

# SEC-2000 USER

Intel Atom® x7-E3950 (Apollo Lake) Expandable Fanless System,  
Isolated COM, PCI/PCIe Slots, -40°C to 75°C Operation

# Manual

# Record of Revision

---

Version	Date	Page	Description	Remark
0.10	02/27/2019	All	Preliminary Release	
1.00	03/05/2019	All	Official Release	
1.10	03/14/2019	2, 4, 13, 18, 19, 22	Update	
1.20	01/27/2022	11, 24	Update	
1.30	05/30/2023	6, 31, 65, 70	Update	
1.40	06/30/2023	78-80	Update	

# Disclaimer

This manual is released by Vecow Co., Ltd. for reference purpose only. All product offerings and specifications are subject to change without prior notice. It does not represent commitment of Vecow Co., Ltd. Vecow shall not be liable for direct, indirect, special, incidental, or consequential damages arising out of the use of the product; documentation; or for any infringements upon the rights of third parties, which may result from such use.

# Declaration of Conformity

## **FCC**

This equipment has been tested and found to comply with the limits for a Class A digital device, pursuant to part 15 of the FCC Rules. These limits are designed to provide reasonable protection against harmful interference when the equipment is operated in a commercial environment. This equipment generates, uses, and can radiate radio frequency energy, and if it is not installed and used in accordance with the instruction manual, it may cause harmful interference to radio communications. Operation of this equipment in a residential area is likely to cause harmful interference in which case the user will be required to correct the interference at his own expense.

## **CE**

The products described in this manual comply with all applicable European Union (CE) directives if it has a CE marking. For computer systems to remain CE compliant, only CE-compliant parts may be used. Maintaining CE compliance also requires proper cable and cabling techniques.

# Copyright and Trademarks

This document contains proprietary information protected by copyright. No part of this publication may be reproduced in any form or by any means, electric, photocopying, recording or otherwise, without prior written authorization by Vecow Co., Ltd. The rights of all the brand names, product names and trademarks belong to their respective owners.

## Order Information

---

Part Number	Description
SEC-2220	SEC-2000, Intel Atom® x7-E3950 SoC, 2 GigE LAN support IEEE 1588 (PTP), 2 PCIe x1, 4 USB, 4 COM w/2 Isolated, 1 SIM, 16 GPIO
SEC-2211	SEC-2000, Intel Atom® x7-E3950 SoC, 2 GigE LAN support IEEE 1588 (PTP), 1 PCIe x1, 1 PCI, 4 USB, 4 COM w/2 Isolated, 1 SIM, 16 GPIO

## Order Accessories

---

Part Number	Description
DDR3L8G	Certified DDR3L-1866/1600 8G RAM
DDR3L4G	Certified DDR3L-1866/1600 4G RAM
PWA-160W-WT-12V	160W, 12V, 85V AC to 264V AC Power Adapter with 3-pin Terminal Block, Wide Temperature -30°C to +70°C
PWA-120W-12V	120W, 12V, 90V AC to 264V AC Power Adapter with 3-pin Terminal Block
4G Module	Mini PCIe 4G/GPS Module with Antenna
WiFi & Bluetooth	WiFi & Bluetooth Module with Antenna
FAN Module	Non-Adjustable Fan Module for SEC Series

# Table of Contents

<b>CHAPTER 1</b>	<b>GENERAL INTRODUCTION</b>	<b>1</b>
	1.1 Overview	1
	1.2 Features	2
	1.3 Product Specification	2
	1.3.1 Specifications of SEC-2220	2
	1.3.2 Specifications of SEC-2211	4
	1.4 Mechanical Dimension	5
	1.4.1 Dimensions of SEC-2000 series	5
<b>CHAPTER 2</b>	<b>GETTING TO KNOW YOUR SEC-2000</b>	<b>6</b>
	2.1 Packing List for SEC-2000	6
	2.2 Front Panel I/O & Functions	7
	2.3 Main Board Expansion Connectors	15
	2.4 Main Board Jumper Settings	34
<b>CHAPTER 3</b>	<b>SETUP</b>	<b>37</b>
	3.1 How to Open Your SEC-2000	37
	3.2 Installing DDR3L Module	39
	3.3 Installing Mini PCIe Card	40
	3.4 Installing Antenna Cable	41
	3.5 Installing SIM Card	42
	3.6 Installing SSD/HDD	44
	3.7 Installing PCI/PCIe Card	47
	3.8 Mounting Your SEC-2000	48

<b>CHAPTER 4</b>	<b>BIOS SETUP</b>	<b>49</b>
4.1	Entering Setup	49
4.2	Main Menu	50
4.3	Advanced	50
4.4	Chipset	56
4.5	Security	62
4.6	Boot	63
4.7	Save & Exit	64
<b>APPENDIX A</b>	<b>: GPIO Guide</b>	<b>65</b>
<b>APPENDIX B</b>	<b>: Software Functions</b>	<b>68</b>
<b>APPENDIX C</b>	<b>: RAID Functions</b>	<b>70</b>
<b>APPENDIX D</b>	<b>: Power Consumption</b>	<b>74</b>
<b>APPENDIX E</b>	<b>: Supported Memory &amp; Storage List</b>	<b>76</b>
<b>APPENDIX F</b>	<b>: Install Win11(BIOS TPM Setting)</b>	<b>78</b>

# 1

## GENERAL INTRODUCTION

### 1.1 Overview

SEC-2000 is an Expandable Fanless Embedded System for smart industrial-grade IoT applications. With low-power quad-core Intel Atom<sup>®</sup> x7-E3950 processor (Apollo Lake) engine, single DDR3L SO-DIMM supports up to 8GB memory; Advanced Intel<sup>®</sup> HD graphics 505 supports DirectX 12, OpenGL 4.3 and OpenCL 2.1 API, up to 4K resolution; Vecow SEC-2000 delivers more than 150% system performance improved and up to 300% graphics performance enhanced than the embedded engine powered by the former generation Intel Atom<sup>®</sup> E3845 SoC.

Supports VGA and lockable HDMI dual display, built-in dual GigE LAN supporting IEEE 1588 Precision Time Protocol (PTP), 4 COM RS-232/422/485 with 2 Isolated protection, 16 GPIO, 4 USB, SIM socket for WiFi/4G/3G/LTE/GPRS/UMTS, 2 PCI/PCIe slots, 2 Mini PCIe expansion, 1 SATA III, 1 mSATA, 1 internal 2.5" SSD/HDD bracket for storage, 12V DC power input, remote power switch, TPM 2.0 supported, EN50155 & EN50121 compliant, rugged design for fanless -40°C to 75°C operation, Vecow SEC-2000 features compact integrated functions with flexible configurations to meet your requirements for smart embedded applications.

With outstanding system performance, compact integrated functions, rugged reliability, system-oriented solution and versatile configurations, Vecow SEC-2000 Series Expandable Fanless Embedded System is your smart solution for Smart Manufacturing, Intelligent Surveillance, Factory Automation, Robotic Control or any Industrial IoT/Industry 4.0 applications.

## 1.2 Features

- Quad Core Intel Atom® x7-E3950 SoC (Apollo Lake-I) delivering lower power consumption
- Compact & Fanless design, -40°C to 75°C operating temperature
- Supports HDMI & VGA dual display, up to 4K resolution
- DDR3L 1866MHz memory supports up to 8GB
- 2 GigE LAN support IEEE 1588 (PTP)
- 4 COM RS-232/422/485 with 2 Isolated
- 4 USB, 16 GPIO, 1 SIM socket
- Expansions : 2 PCIe x16 slots, 2 Mini PCIe, 1 SATA III
- SIM socket for WiFi/4G/3G/LTE/GPRS/UMTS
- 12V DC Power Input
- TPM 2.0 supported

## 1.3 Product Specification

### 1.3.1 Specifications of SEC-2220

System	
Processor	Intel Atom® x7-E3950 processor (Apollo Lake-I)
BIOS	AMI
SIO	IT8786E
Memory	1 DDR3L 1866MHz SO-DIMM, up to 8GB (Non-ECC)
OS	Windows 10, Linux
I/O Interface	
Serial	4 COM RS-232/422/485 with 2 Isolated
USB	<ul style="list-style-type: none"> <li>• 2 USB 3.0 (External)</li> <li>• 4 USB 2.0 (2 External, 2 Internal)</li> </ul>
DIO	16 GPIO
LED	Power, HDD, wireless
SIM	1 Internal SIM socket
Expansion	
Mini PCIe	2 Mini PCIe sockets : <ul style="list-style-type: none"> <li>• 1 Mini PCIe for PCIe/USB/SIM card</li> <li>• 1 Mini PCIe for PCIe/USB/Optional mSATA</li> </ul>
PCI/PCIe	2 PCIe x16 slot (PCIe x1 signal supported)



<b>Graphics</b>	
Processor	Intel® HD Graphics 505
Interface	<ul style="list-style-type: none"> <li>• HDMI : Up to 3840 x 2160 @30Hz (Lockable)</li> <li>• VGA : Up to 1920 x 1440 @60Hz</li> </ul>
<b>Storage</b>	
SATA	1 SATA III (6Gbps)
mSATA	1 SATA III (Mini PCIe type, 6Gbps)
Storage Device	1 2.5" SSD/HDD bracket (Internal)
<b>Audio</b>	
Audio Codec	Realtek ALC892, 5.1 Channel HD Audio
Audio Interface	1 Mic-in, 1 Line-out
<b>Ethernet</b>	
LAN 1	Intel® I210 GigE LAN supports IEEE 1588
LAN 2	Intel® I210 GigE LAN supports IEEE 1588
<b>Power</b>	
Power Input	Single 12V DC power input
Power Interface	3-pin Terminal Block : V+, V-, Frame Ground
Remote Switch	2-pin Terminal Block
<b>Others</b>	
TPM	Optional Infineon SLB9665 supports TPM 2.0, LPC interface
Watchdog Timer	Reset : 1 to 255 sec./min. per step
HW Monitor	Monitoring temperature, voltages. Auto throttling control when CPU overheats.
<b>Mechanical</b>	
Dimension	125mm x 210mm x 160mm (4.9" x 8.3" x 6.3")
Weight	3.5 kg (7.7 lb)
Mounting	Wallmount by mounting bracket
<b>Environment</b>	
Operating Temperature	-40°C to 75°C (-40°F to 167°F)
Storage Temperature	-40°C to 85°C (-40°F to 185°F)
Humidity	5% to 95% Humidity, non-condensing
Relative Humidity	95% at 85°C
Shock	<ul style="list-style-type: none"> <li>• IEC 60068-2-27</li> <li>• SSD : 50G @ wallmount, Half-sine, 11ms</li> </ul>
Vibration	<ul style="list-style-type: none"> <li>• IEC 60068-2-64</li> <li>• SSD : 5Grms, 5Hz to 500Hz, 3 Axis</li> </ul>
EMC	CE, FCC, EN50155, EN50121-3-2

### 1.3.2 Specifications of SEC-2211

<b>System</b>	
Processor	Intel Atom® x7-E3950 processor (Apollo Lake-I)
BIOS	AMI
SIO	IT8786E
Memory	1 DDR3L 1866MHz SO-DIMM, up to 8GB (Non-ECC)
OS	Windows 10, Linux
<b>I/O Interface</b>	
Serial	4 COM RS-232/422/485 with 2 Isolated
USB	<ul style="list-style-type: none"> <li>• 2 USB 3.0 (External)</li> <li>• 4 USB 2.0 (2 External, 2 Internal)</li> </ul>
DIO	16 GPIO
LED	Power, HDD, wireless
SIM	1 Internal SIM socket
<b>Expansion</b>	
Mini PCIe	2 Mini PCIe sockets : <ul style="list-style-type: none"> <li>• 1 Mini PCIe for PCIe/USB/SIM card</li> <li>• 1 Mini PCIe for PCIe/USB/Optional mSATA</li> </ul>
PCI/PCIe	<ul style="list-style-type: none"> <li>• 1 PCIe x16 Slot</li> <li>• 1 PCI Slot (PCIe x1 signal supported)</li> </ul>
<b>Graphics</b>	
Processor	Intel® HD Graphics 505
Interface	<ul style="list-style-type: none"> <li>• HDMI : Up to 3840 x 2160 @30Hz (Lockable)</li> <li>• VGA : Up to 1920 x 1440 @60Hz</li> </ul>
<b>Storage</b>	
SATA	1 SATA III (6Gbps)
mSATA	1 SATA III (Mini PCIe type, 6Gbps)
Storage Device	1 2.5" SSD/HDD bracket (Internal)
<b>Audio</b>	
Audio Codec	Realtek ALC892, 5.1 Channel HD Audio
Audio Interface	1 Mic-in, 1 Line-out
<b>Ethernet</b>	
LAN 1	Intel® I210 GigE LAN supports IEEE 1588
LAN 2	Intel® I210 GigE LAN supports IEEE 1588
<b>Power</b>	
Power Input	Single 12V DC power input
Power Interface	3-pin Terminal Block : V+, V-, Frame Ground
Remote Switch	2-pin Terminal Block

Others	
TPM	Optional Infineon SLB9665 supports TPM 2.0, LPC interface
Watchdog Timer	Reset : 1 to 255 sec./min. per step
HW Monitor	Monitoring temperature, voltages. Auto throttling control when CPU overheats.
Mechanical	
Dimension	125mm x 210mm x 160mm (4.9" x 8.3" x 6.3")
Weight	3.5 kg (7.7 lb)
Mounting	Wallmount by mounting bracket
Environment	
Operating Temperature	-40°C to 75°C (-40°F to 167°F)
Storage Temperature	-40°C to 85°C (-40°F to 185°F)
Humidity	5% to 95% Humidity, non-condensing
Relative Humidity	95% at 85°C
Shock	<ul style="list-style-type: none"> <li>• IEC 60068-2-27</li> <li>• SSD : 50G @ wallmount, Half-sine, 11ms</li> </ul>
Vibration	<ul style="list-style-type: none"> <li>• IEC 60068-2-64</li> <li>• SSD : 5Grms, 5Hz to 500Hz, 3 Axis</li> </ul>
EMC	CE, FCC, EN50155, EN50121-3-2

## 1.4 Mechanical Dimension

### 1.4.1 Dimensions of SEC-2000 series

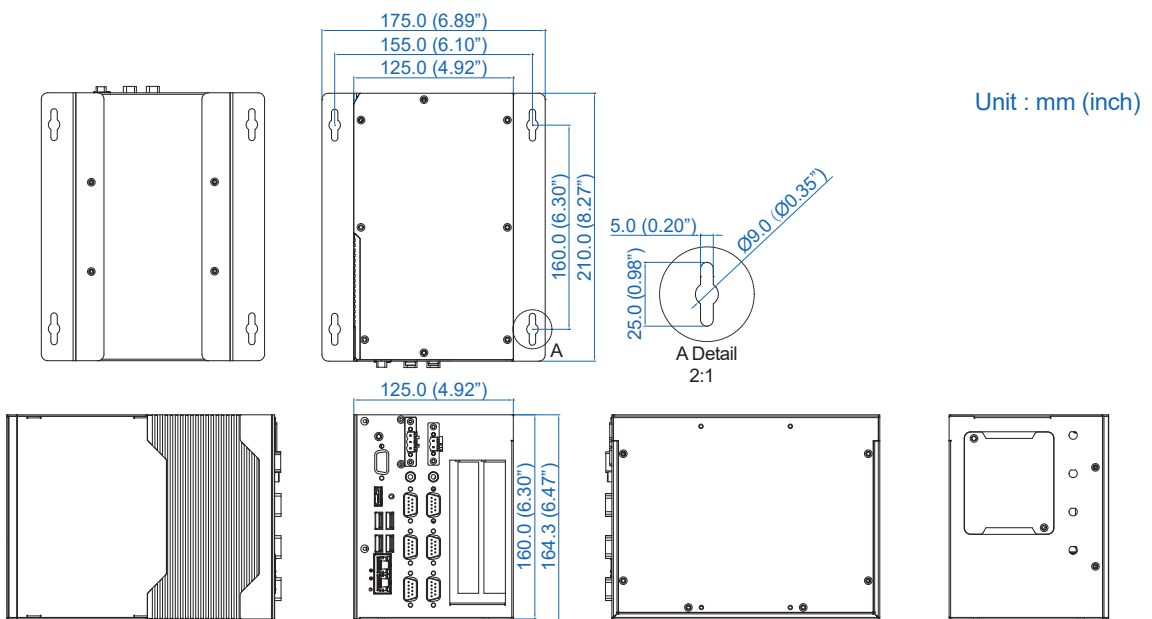

# 2

## GETTING TO KNOW YOUR SEC-2000

### 2.1 Packing List for SEC-2000

Item	Description	Qty
1	SEC-2220/2211 Embedded System	1
2	SEC-2000 accessory box, which contains <ul style="list-style-type: none"><li>• Wall-mounting bracket</li><li>• Foot Pad</li><li>• Screws &amp; Terminal block</li></ul>	2 4 (Below)

Item	Description	Outlook	Usage	P/N	Qty
1	PHILLPIS M4x16L with washer, Ni		Mount	53-24D6416-30B	4
2	PHILLPIS M2.5x6L, Ni		Mini PCIe slot	53-2426906-30B	2
3	PHILLPIS M3x6L		SSD/HDD	53-2450000-215	8
4	Terminal block 3-pin (5.0mm)		DC-IN	51-2411R03-S1B	1
5	Terminal block 2-pin (5.0mm)		Switch	51-2411R02-S1B	1
8	PHILLPIS M3x4L		Wall mount bracket	53-M000450-301	4

## 2.2 Front Panel I/O & Functions

In Vecow's SEC-2000 series family, all I/O connectors are located on the front panel, such as audio, USB, VGA, HDMI, and serial ports.

### 2.2.1 SEC-2000 Front I/O & Functions

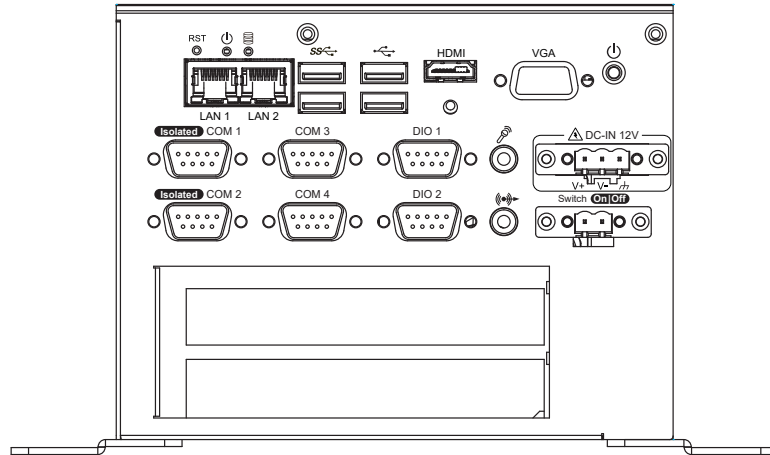

#### 2.2.1.1 Reset Tact Switch

It is a hardware reset switch. Use this switch to reset the system without power off the system. Press the Reset Switch for a few seconds, and then the reset function will be enabled.

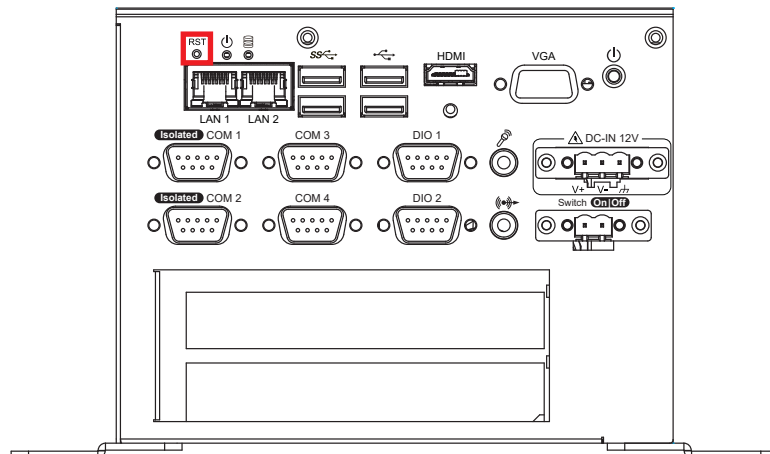

### 2.2.1.2 Power Button

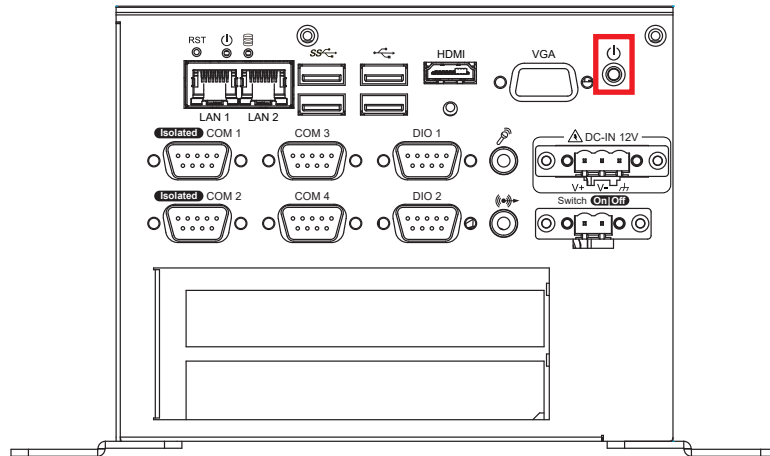

The Power Button is a non-latched switch. To power on the system, press the power button and then the Green LED is lightened. To power off the system, you can either command shutdown by OS operation or just simply press the power button. If system error, you can just press the power button for 4 seconds to shut down the machine directly. Please do note that a 4-second interval between each 2 power-on/power-off operation is necessary in normal working status. (For example, once turning off the system, you have to wait for 4 seconds to initiate another power-on operation.)

### 2.2.1.3 PWR and HDD LED Indicator

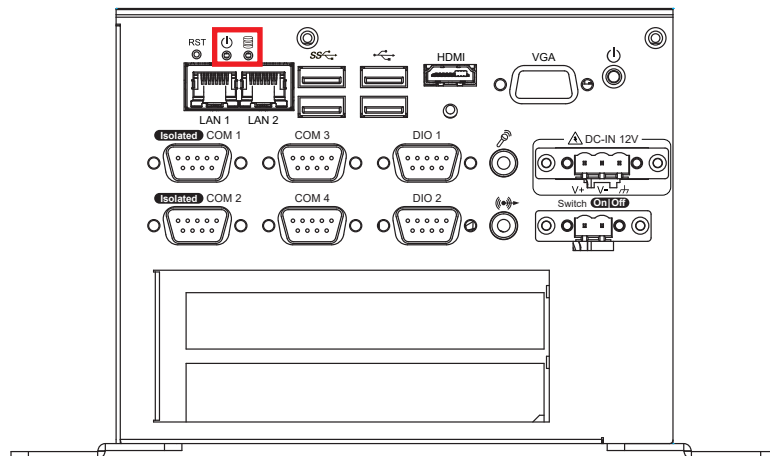

Power LED/Green (Left) : If the LED is solid green, it indicates that the system is powered on.

HDD LED/Orange (Right) : If the LED is on, it indicates that the system's storage is functional. If it is off, it indicates that the system's storage is not functional. If it is flashing, it indicates data access activities.

LED Color	Indication	System Status
Orange	HDD	<ul style="list-style-type: none"> <li>On/Off : Storage status, function or not.</li> <li>Twinkling : Data transferring.</li> </ul>
Green	Power	System power status (on/off)

### 2.2.1.4 VGA

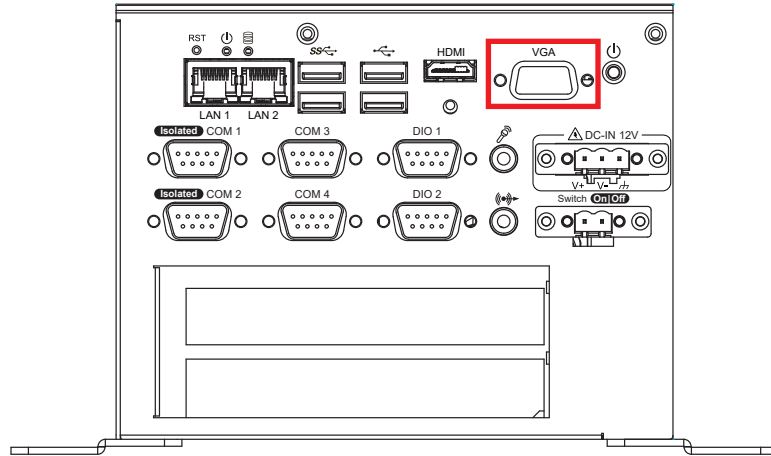

Onboard VGA Port supports auxiliary channel mode. The connection supports up to 1920 x 1440 resolution at 60Hz.

### 2.2.1.5 HDMI

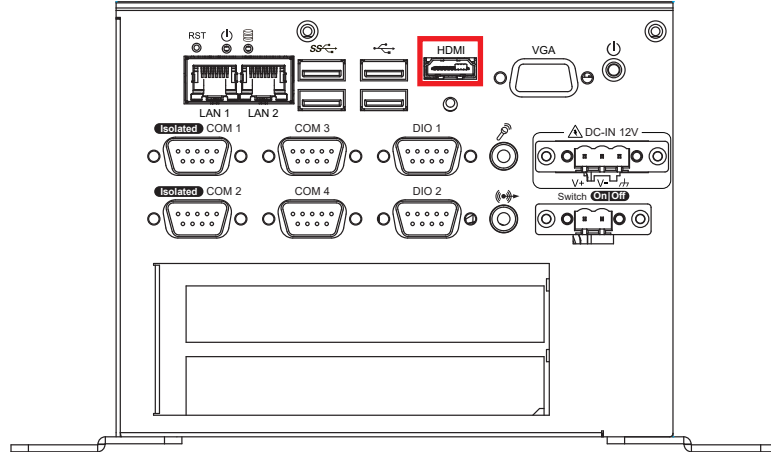

Onboard HDMI Port supports DDC channel mode. The connection supports up to 3840 x 2160 resolution at 30Hz.

### 2.2.1.6 USB 2.0

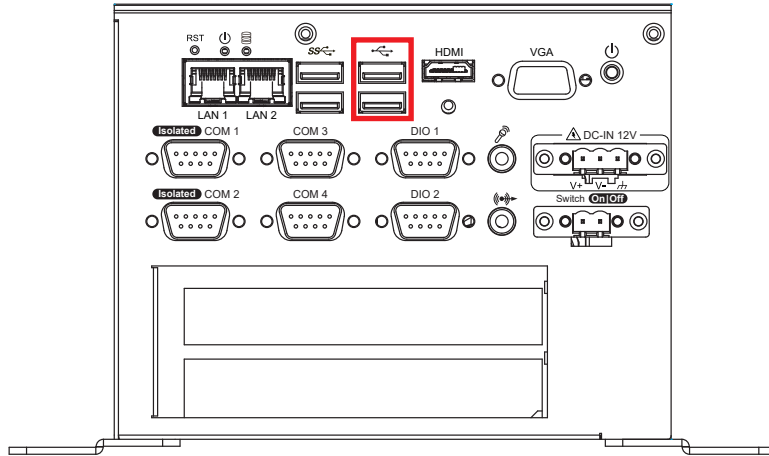

There are 2 USB 2.0 connections available supporting up to 480MB per second data rate.

### 2.2.1.7 USB 3.0

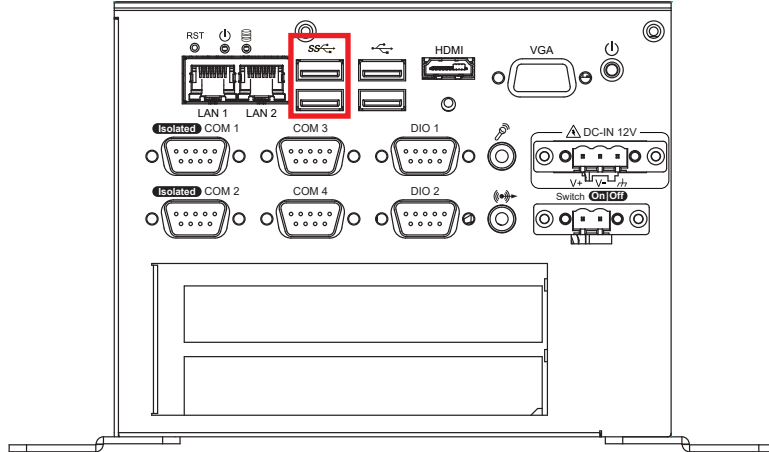

There are 2 USB 3.0 connections available supporting up to 5GB per second data rate. It is also compliant with the requirements of Super Speed (SS), High Speed (HS), Full Speed (FS) and Low Speed (LS).



### 2.2.1.8 Audio Jack

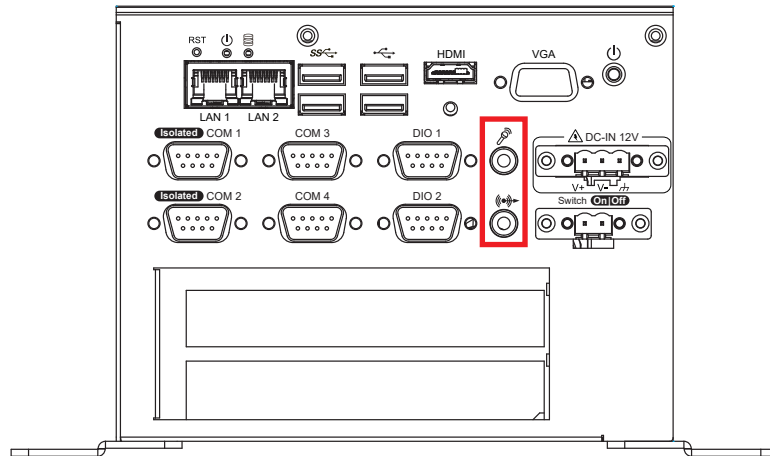

There are 2 audio connectors, Mic-in (Top) and Line-out (Bottom). Onboard Realtek ALC892 audio codec supports 5.1 channel HD audio and fully complies with Intel<sup>®</sup> High Definition Audio (Azalia) specifications. To utilize the audio function in Windows platform, you need to install corresponding drivers for Realtek ALC892 codec.

### 2.2.1.9 10/100/1000 Mbps Ethernet Port

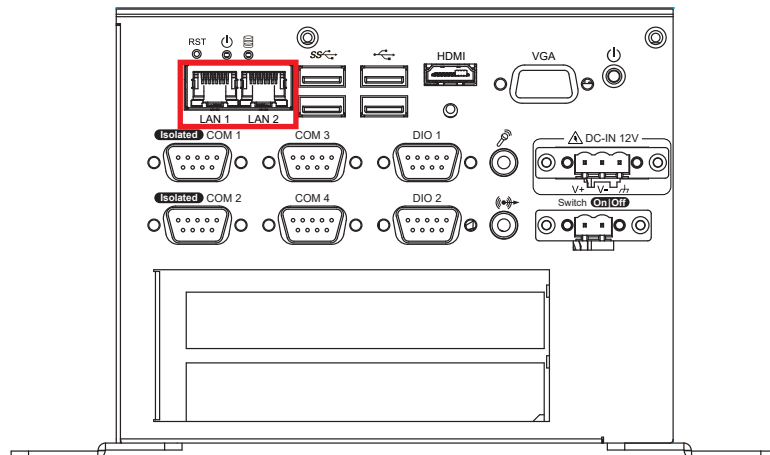

There are 2 8-pin RJ-45 jacks supporting 10/100/1000 Mbps Ethernet connections. LAN 1 (Left side) and LAN 2 (Right side) are powered by Intel<sup>®</sup> I210 Ethernet engine with IEEE 1588, The Precision Time Protocol (PTP) function. Using suitable RJ-45 cable, you can connect SEC-2000 system to a computer, or to any other devices with Ethernet connection; for example, a hub or a switch. Moreover, both LAN 1 and LAN 2 support Wake on LAN and Pre-boot functions. The pinouts of LAN 1 and LAN 2 are listed as follows :

Each LAN port is supported by standard RJ-45 connector with LED indicators to present Active/Link/Speed status of the connection. The LED indicator on the right bottom corner lightens in solid green when the cable is properly connected to a 100Mbps Ethernet network; The LED indicator on the right bottom corner lightens in solid orange when the cable is properly connected to a 1000Mbps Ethernet network; The left LED will keep twinkling/off when Ethernet data packets are being transmitted/received.

LED Location	LED Color	10Mbps	100Mbps	1000Mbps
Right	Green/ Orange	Off	Solid Green	Solid Orange
Left	Yellow	Twinkling Yellow	Twinkling Yellow	Twinkling Yellow

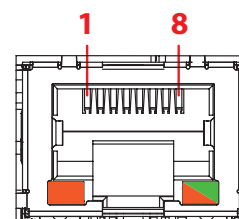

### 2.2.1.10 Serial Port COM

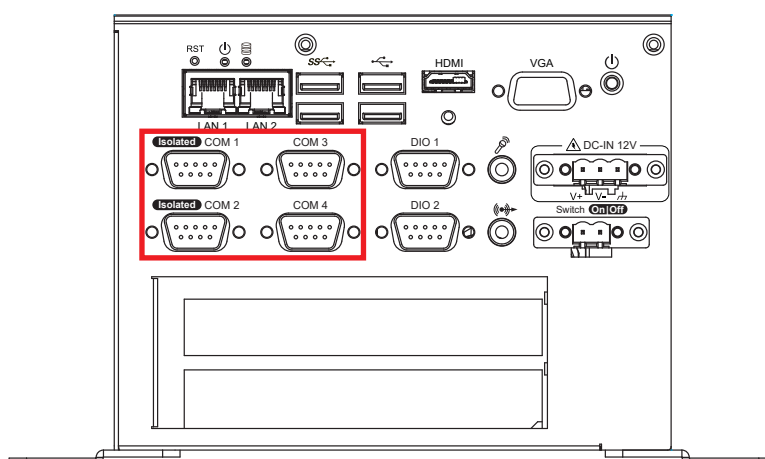

Serial port can be configured for RS-232, RS-422, or RS-485 with auto flow control communication. The default definition is RS-232. If you want to change to RS-422 or RS-485, you can find the setting in BIOS.

BIOS Setting	Function
COM 1, 2 (Isolated) COM 3, 4	RS-232
	RS-422 (5-wire)
	RS-422 (9-wire)
	RS-485
	RS-485 w/z auto-flow control

The pin assignments are listed in the following table :

Serial Port	Pin No.	RS-232	RS-422 (5-wire)	RS-422 (9-wire)	RS-485 (3-wire)
1 to 4	1	DCD	TXD-	TXD-	DATA-
	2	RXD	TXD+	TXD+	DATA+
	3	TXD	RXD+	RXD+	-----
	4	DTR	RXD-	RXD-	-----
	5	GND	GND	GND	GND
	6	DSR	-----	RTS-	-----
	7	RTS	-----	RTS+	-----
	8	CTS	-----	CTS+	-----
	9	RT	-----	CTS-	-----

### 2.2.1.11 GPIO

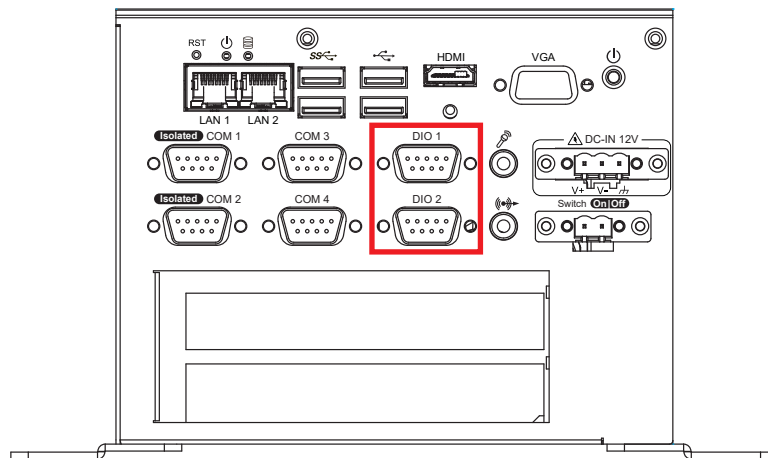

There is a 16-bit GPIO connection. Please refer to below table to see the pin definition in details. DIO1 and DIO2 Pin define are as below.

Pin No.	DIO1 Definition	DIO2 Definition
1	SIO_GPO70	SIO_GPI80
2	SIO_GPO71	SIO_GPI81
3	SIO_GPO72	SIO_GPI82
4	SIO_GPO73	SIO_GPI83
5	SIO_GPO74	SIO_GPI84
6	SIO_GPO75	SIO_GPI85
7	SIO_GPO76	SIO_GPI86
8	SIO_GPO77	SIO_GPI87
9	GND	GND

### 2.2.1.12 Power Terminal Block

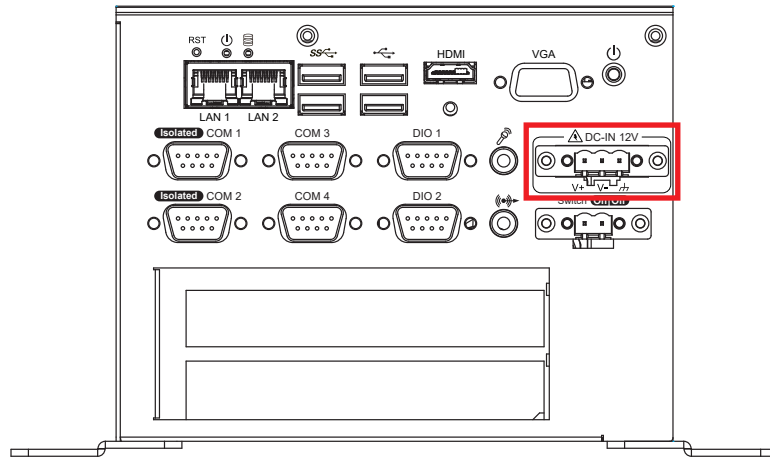

This system supports 12V DC only power input by terminal block. In the normal power operation, power LED lightens in solid green and supports up to 65V surge protection.

### 2.2.1.13 Remote Power On/Off Switch

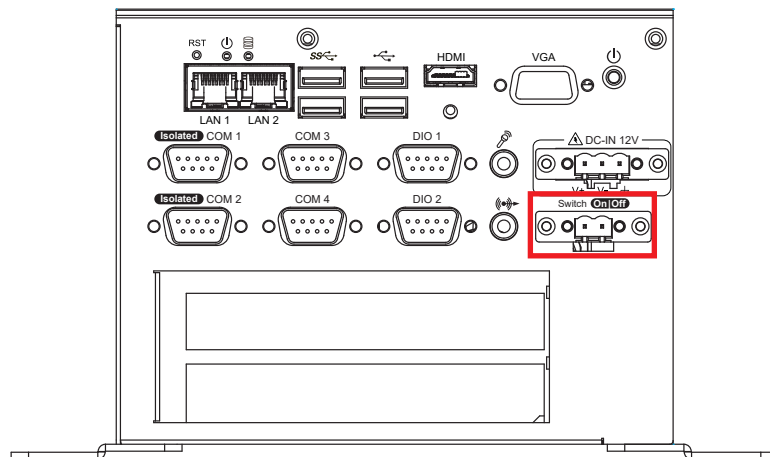

It is a 2-pin power-on or power-off switch through Phoenix Contact terminal block. You could turn on or off the system power by using this contact. This terminal block supports dual function of power-on/power-off (instant off or delay 4 second), and suspend modes.

### 2.2.1.14 Add Card

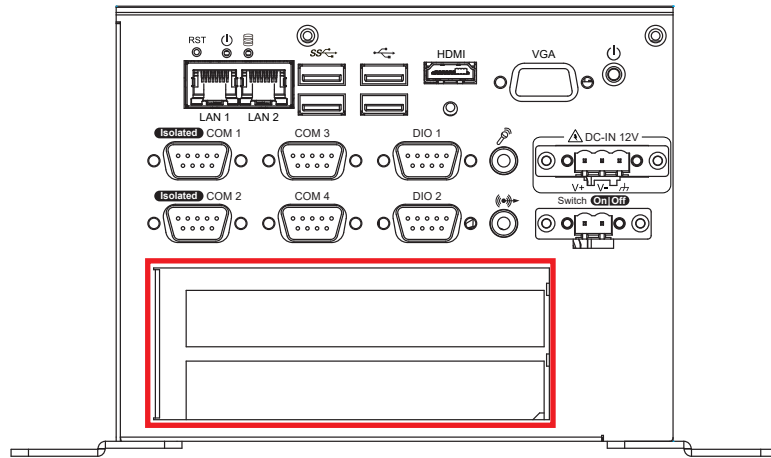

There are 2 flexible expansion feature SEC-2220/2211. Optional for 2 PCIe x16 slots (SEC-2220) or 1 PCIe x16 and 1 PCI slots (SEC-2211) FHHL add on card. (Each signal is PCIe x1)

## 2.3 Main Board Expansion Connectors

### 2.3.1 SEC-2000 Main Board Pin Header Location

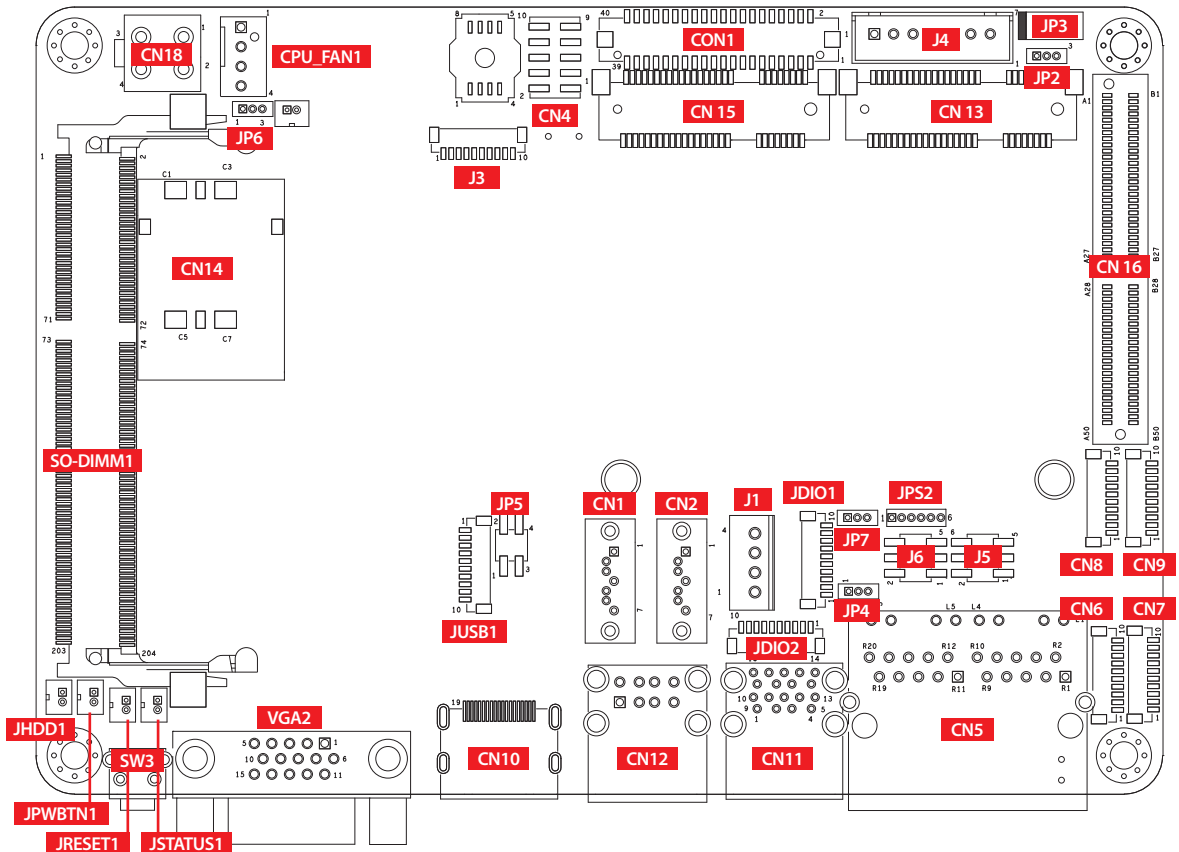

### 2.3.2 JPWBTN, JRESET, JSTATUS, JHDD : Miscellaneous Pin Header

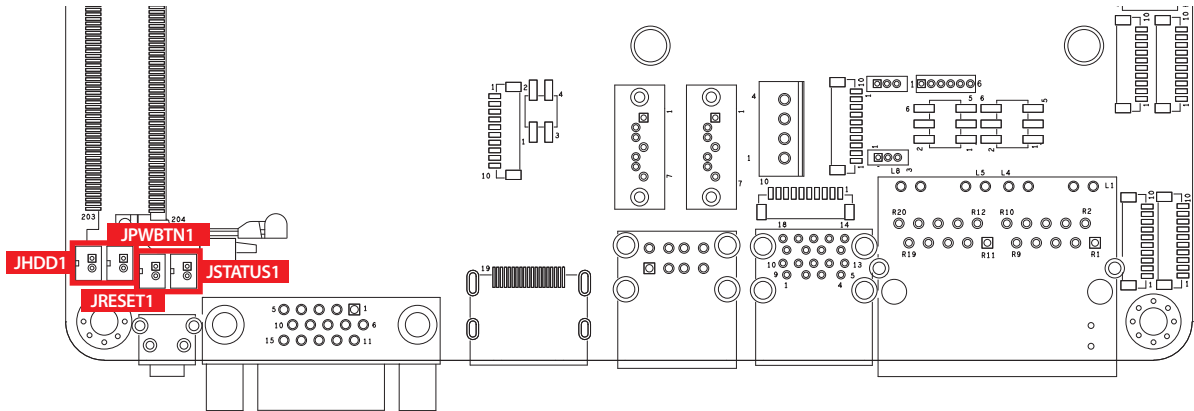

These pin headers can be used as a backup for following functions, hard drive LED indicator, reset button, power LED indicator, and power-on/off button, which already be accessed by the front panel. The pinouts of Miscellaneous port are listed in following table :

	Group	Pin No.	Description
	JPWBTN	1	GND
		2	FP_PWR_BTN_IN
	JRESET	1	GND
		2	FP_RST_BTN_N
	JSTATUS	1	PWR_LED_N
		2	PWR_LED_P
	JHDD	1	HDD_LED_N
		2	HDD_LED_P

### 2.3.3 Battery

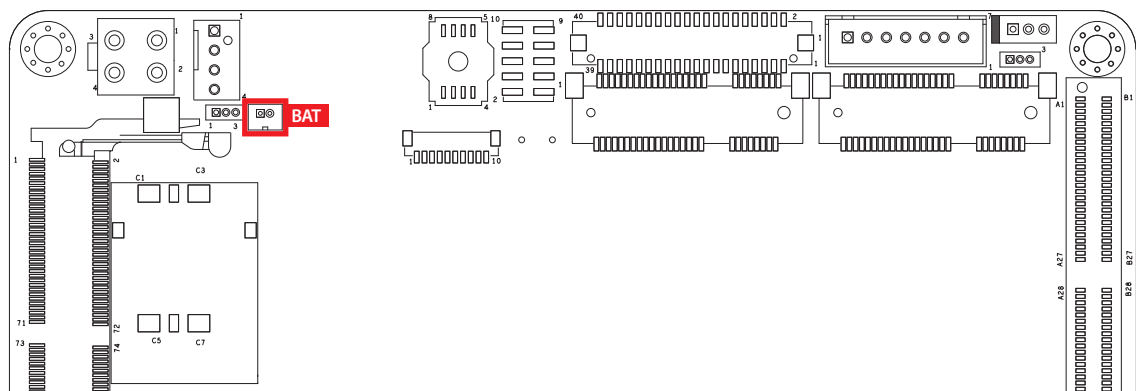

The SEC-2000 real-time clock is powered by a lithium battery. It is equipped with Panasonic BR2032 190mAh lithium battery. It is recommended that you should not replace the lithium battery on your own. If the battery needs to be changed, please contact the Vecow RMA service team.

### 2.3.4 CN4 : Audio Connector

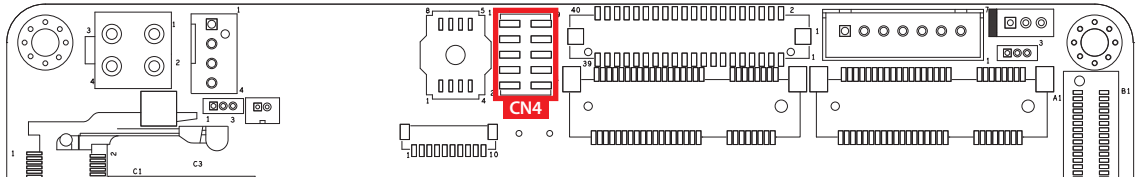

There are 3 audio connectors, Mic-in, Line-in and Line-out, in the top side of SEC-2000. Onboard Realtek ALC892 audio codec supports 5.1 channel HD audio and fully complies with Intel® High Definition Audio (Azalia) specifications.

To utilize the audio function in Windows platform, you need to install corresponding drivers for both Intel Apollo lake chipset and Realtek ALC892 codec. Please refer to [Chapter 4](#) for more details of driver installation.

The pinouts of Audio port are listed in following table :

Pin No.	Definition	Pin No.	Definition
1	A_z_MIC1-L	2	GND_A
3	A_z_MIC1-R	4	GND_EARTH
5	A_z_LINEO-R	6	A_z_LINEI-R
7	F_IO_SENSE	8	GND_EARTH
9	A_z_LINEO-L	10	A_z_LINEI-L

### 2.3.5 JUSB1 : Internal USB 2.0 Connector

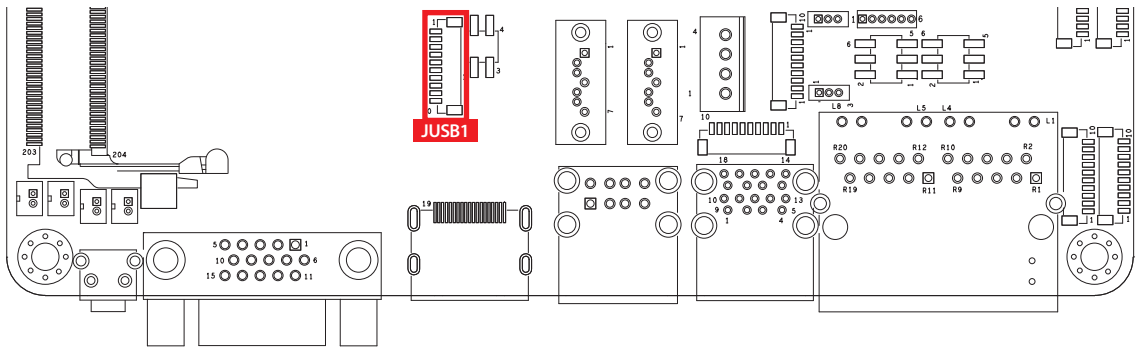

SEC-2000 main board provides maximum eight expansion USB ports. The USB interface supports 480Mbps transfer rate which is complied with high speed USB specification Rev. 2.0.

The USB interface is accessed through one 10-pin JST 1.0mm connector. You will need an adapter cable while using a standard USB connector. The adapter cable is a 10-pin connector on one end and a USB connector on the other. The pin assignments of JUSB1 are listed in the following table :

Pin No.	Definition	Pin No.	Definition
1	USB_VCC	2	USB_VCC
3	USB_VCC	4	USB_D_4N
5	USB_D_4P	6	USB_D_5N
7	USB_D_5P	8	GND
9	GND	10	GND

### 2.3.6 JP5, CN15 : Mini PCIe, mSATA

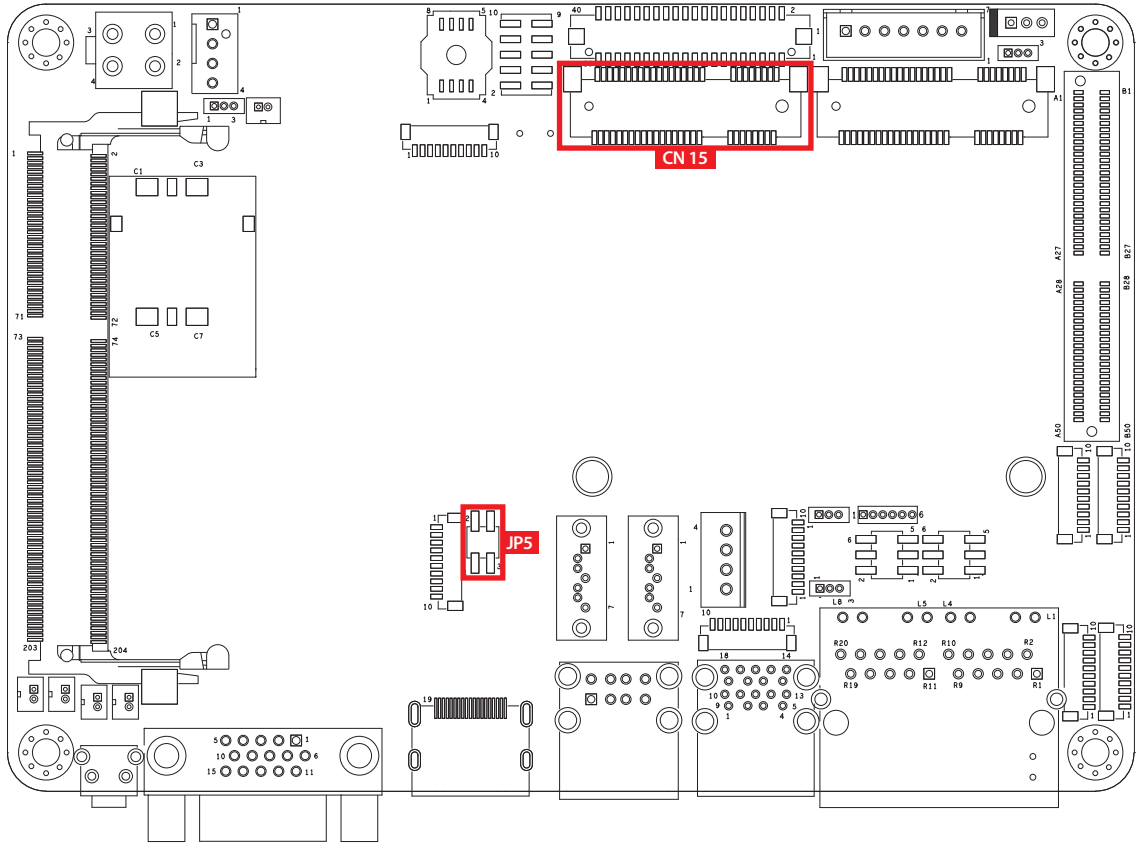

Both mSATA and Mini PCIe share the same form factor and similar electrical pinout assignments on their connectors. You can adjust JP5 to choose mSATA or Mini PCIe function. The pin assignments of CN15 and JP5 are listed in the following table :

#### JP5

	Pin No.	Function
	1-3/2-4	mSATA
	NC	Mini PCIe (Default)

#### CN15

Pin No.	Signal Name	Pin No.	Signal Name
51	Reserved	52	+3.3Vaux
49	Reserved	50	GND
47	Reserved	48	+1.5V



Pin No.	Signal Name	Pin No.	Signal Name
45	Reserved	46	Reserved
43	GND	44	Reserved
41	+3.3Vaux	42	Reserved
39	+3.3Vaux	40	GND
37	GND	38	USB_D+
35	GND	36	USB_D-
33	PETp0	34	GND
31	PETn0	32	SMB_DATA
29	GND	30	SMB_CLK
27	GND	28	+1.5V
25	PERp0	26	GND
23	PERn0	24	+3.3Vaux
21	GND	22	PERST#
19	Reserved	20	reserved
17	Reserved	18	GND
Mechanical Key			
15	GND	16	UIM_VPP
13	REFCLK+	14	UIM_RESET
11	REFCLK-	12	UIM_CLK
9	GND	10	UIM_DATA
7	CLKREQ#	8	UIM_PWR
5	Reserved	6	1.5V
3	Reserved	4	GND
1	WAKE#	2	3.3Vaux

### 2.3.7 CN13, SIM : Mini PCIe

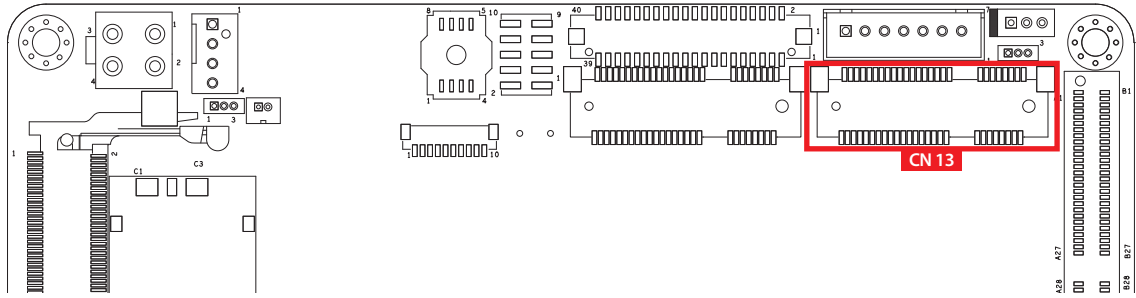

Note : The SIM card socket does not support hot-plug. Please make sure to unplug the system power before inserting the SIM card(s).

The pin assignments of CN13 are listed in the following table :

Pin No.	Signal Name	Pin No.	Signal Name
51	Reserved	52	+3.3Vaux
49	Reserved	50	GND
47	Reserved	48	+1.5V
45	Reserved	46	Reserved
43	GND	44	Reserved
41	+3.3Vaux	42	Reserved
39	+3.3Vaux	40	GND
37	GND	38	USB_D+
35	GND	36	USB_D-
33	PETp0	34	GND
31	PETn0	32	SMB_DATA
29	GND	30	SMB_CLK
27	GND	28	+1.5V
25	PERp0	26	GND
23	PERn0	24	+3.3Vaux
21	GND	22	PERST#
19	Reserved	20	Reserved
17	Reserved	18	GND

Mechanical Key			
Pin No.	Signal Name	Pin No.	Signal Name
15	GND	16	UIM_VPP
13	REFCLK+	14	UIM_RESET
11	REFCLK-	12	UIM_CLK
9	GND	10	UIM_DATA
7	CLKREQ#	8	UIM_PWR
5	Reserved	6	1.5V
3	Reserved	4	GND
1	WAKE#	2	3.3Vaux

### 2.3.8 CN6 To CN9 : COM 1 To COM 4 Serial Port

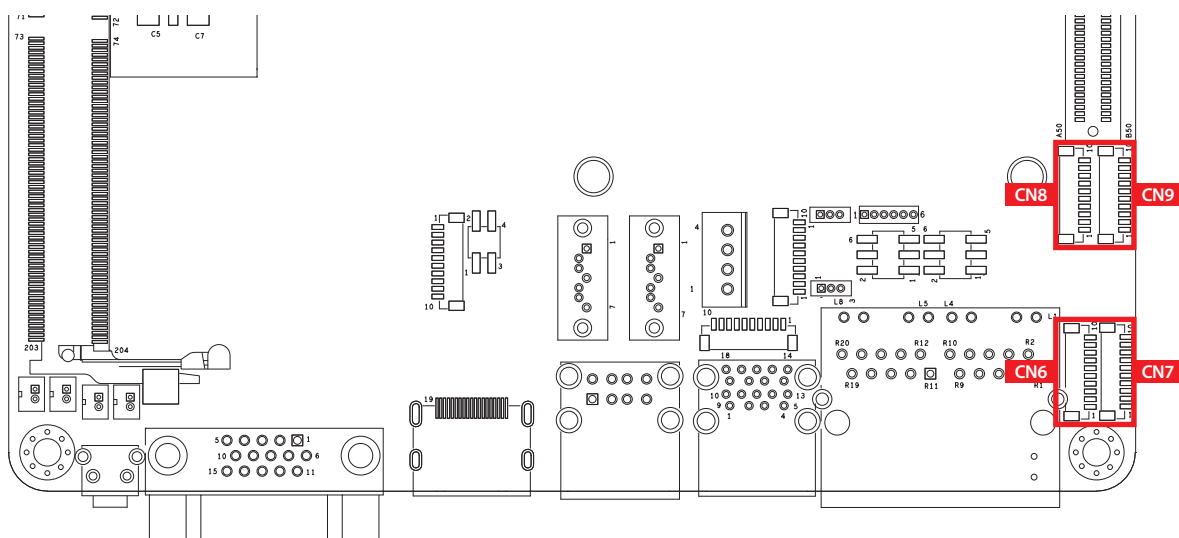

The serial port 1 to 4 can be configured for RS-232, RS-422, or RS-485 with auto flow control communication. The default definition of COM 1 to COM 4 is RS-232. If you want to change to RS-422 or RS-485, you can find the setting in BIOS.

BIOS Setting	Function
COM 1 (CN6) (Isolated) COM 2 (CN7) (Isolated) COM 3 (CN8) COM 4 (CN9)	RS-232
	RS-422 (5-wire)
	RS-422 (9-wire)
	RS-485
	RS-485 w/z auto-flow control

COM 1 to COM 4 pin assignments are listed in the following table :



Serial Port	Pin No.	RS-232	RS-422 (5-wire)	RS-422 (9-wire)	RS-485 (3-wire)
1, 2, 3, 4	1	NC	NC	NC	NC
	2	GND	GND	GND	GND
	3	RI	-----	CTS-	RI
	4	DTR	RXD-	RXD-	-----
	5	CTS	-----	CTS+	-----
	6	TXD	RXD+	RXD+	-----
	7	RTS	-----	RTS+	-----
	8	RXD	TXD+	TXD+	DATA+
	9	DSR	-----	RTS-	-----
	10	DCD	TXD-	TXD-	DATA-

### 2.3.9 VGA

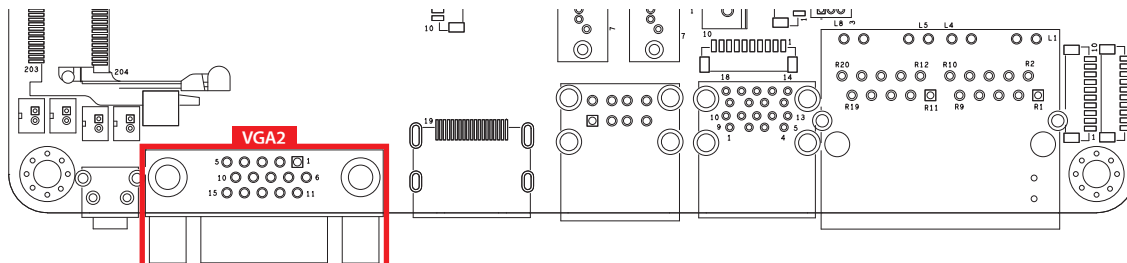

SEC-2000 supports VGA under auxiliary channel mode and up to 1920 x 1440 pixels resolution. The pin assignments of VGA are listed in the following table :

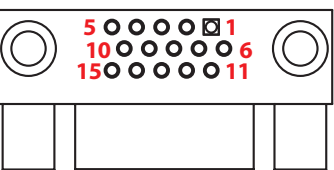

Pin No.	Signal Name	Pin No.	Signal Name
1	Red	2	Green
3	Blue	4	N/C
5	GND	6	GND
7	GND	8	GND
9	P5V	10	GND
11	N/C	12	DDC Data
13	Horizontal Sync	14	Vertical Sync
15	DDC Clock		

### 2.3.10 CN12 : External USB

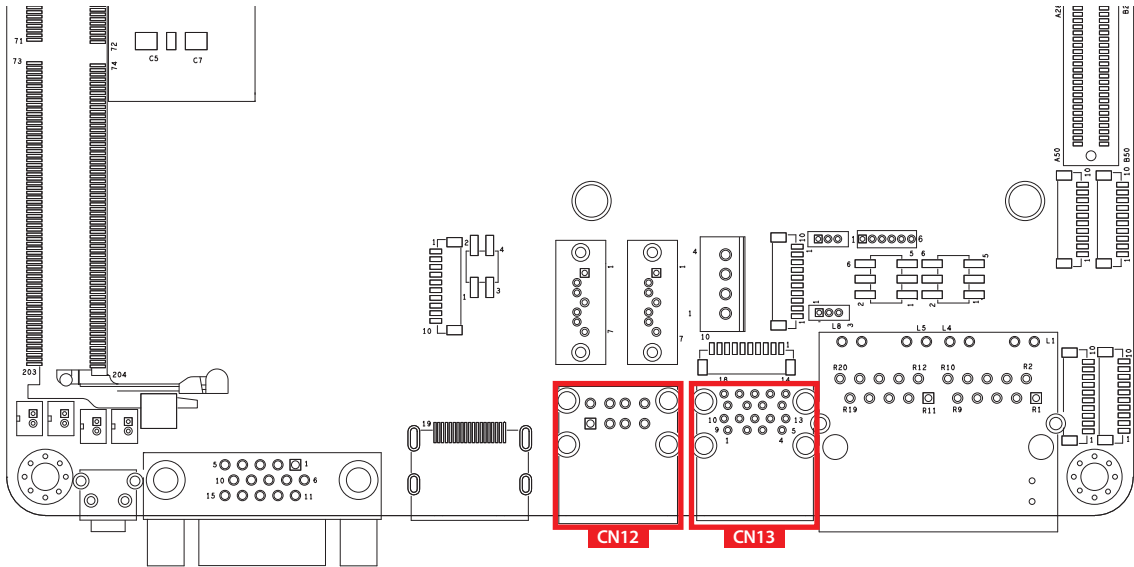

There are 2 USB 2.0 connections available supporting up to 480MB per second data rate in the top side of SEC-2000.

### 2.3.11 CN11 : USB 3.0

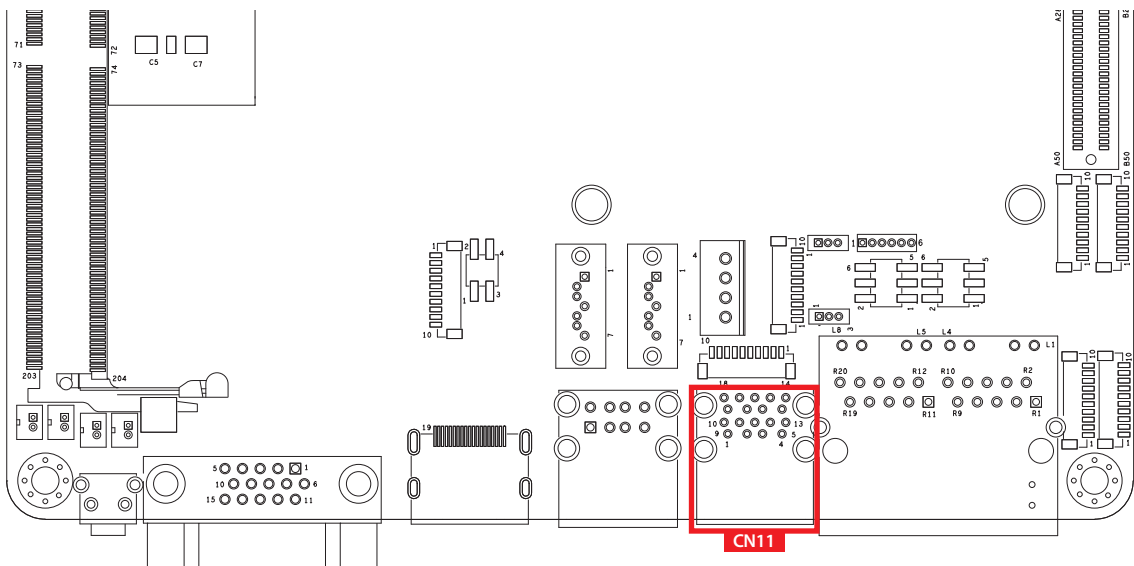

There are 2 USB 3.0 connections available supporting up to 5GB per second data rate. It is also compliant with the requirements of Super Speed (SS), High Speed (HS), Full Speed (FS) and Low Speed (LS).

### 2.3.12 CN5 : LAN

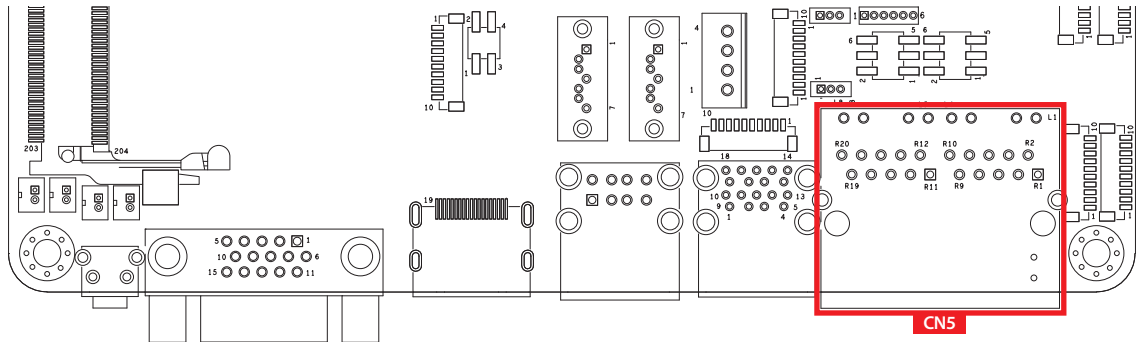

There are 2 8-pin RJ-45 jacks supporting 10/100/1000 Mbps Ethernet connections. LAN 1 (Right side)/LAN 2 (Left side) are powered by Intel® I210 Ethernet engine.

Using suitable RJ-45 cable, you can connect SEC-2000 system to a computer, or to any other devices with Ethernet connection, for example, a hub or a switch. Moreover, both of LAN 1 and LAN 2 supports Wake on LAN and Pre-boot functions. The pinouts of LAN 1 and LAN 2 are listed as follows :

Pin No.	10/100 Mbps	1000Mbps
1	E_TX+	MDI0_P
2	E_TX-	MDI0_N
3	E_RX+	MDI1_P
4	----	MDI2_P
5	-----	MDI2_N
6	E_RX-	MDI1_N
7	-----	MDI3_P
8	-----	MDI3_N

Each LAN port is supported by standard RJ-45 connector with LED indicators to present Active/Link/Speed status of the connection.

The LED indicator on the right bottom corner lightens in solid green when the cable is properly connected to a 100Mbps Ethernet network; The LED indicator on the right bottom corner lightens in solid orange when the cable is properly connected to a 1000Mbps Ethernet network; The left LED will keep twinkling/off when Ethernet data packets are being transmitted/received.

LED Location	LED Color	10Mbps	100Mbps	1000Mbps
Right	Green/ Orange	Off	Solid Green	Solid Orange
Left	Yellow	Twinkling Yellow	Twinkling Yellow	Twinkling Yellow

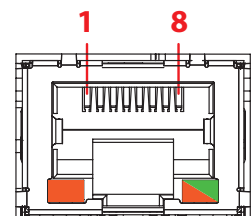

### 2.3.13 CON1, J4 : LVDS

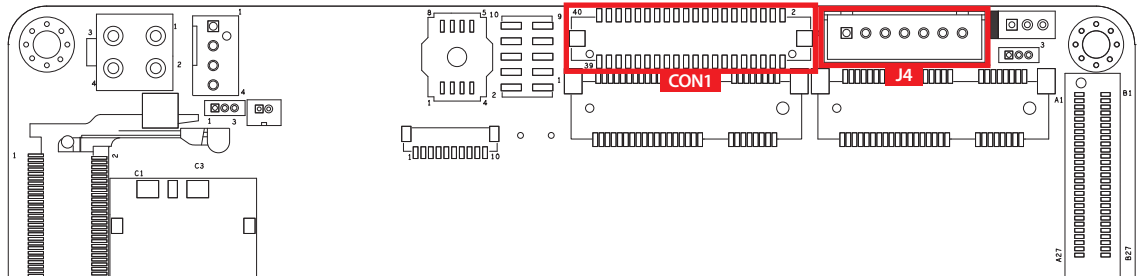

#### CON1

SEC-2000 supports dual-channel 24-bit LVDS display and up to 1920 x 1200 pixels resolution. The pin assignments of CON1 are listed in the following table :

Pin No.	Signal Name	Pin No.	Signal Name
1	PANEL_VDD	2	TXO0-
3	PANEL_VDD	4	TXO0+
5	PANEL_VDD	6	TXO1-
7	GND	8	TXO1+
9	GND	10	TXO2-
11	GND	12	TXO2+
13	GND	14	TXOC-
15	GND	16	TXOC+
17	GND	18	TXO3-
19	GND	20	TXO3+
21	GND	22	TXE0-
23	GND	24	TXE0+
25	GND	26	TXE1-
27	GND	28	TXE1+
29	GND	30	TXE2-
31	GND	32	TXE2+
33	GND	34	TXEC-
35	GND	36	TXEC+
37	GND	38	TXE3-
39	LVDS_DET#	40	TXE3+

## J4

The LCD inverter is connected to J4 via a JST 7-pin, 2.5mm connector providing +5V/+12V power to LCD display. The pin assignments are listed in the following table :

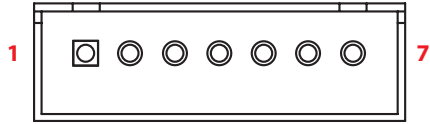
			
Pin No.	Signal Name	Pin No.	Signal Name
1	+5V	2	+12V
3	+12V	4	LBKLT_CTL
5	GND	6	GND
7	LBKLT_EN		

### 2.3.14 CN18 : Power Input

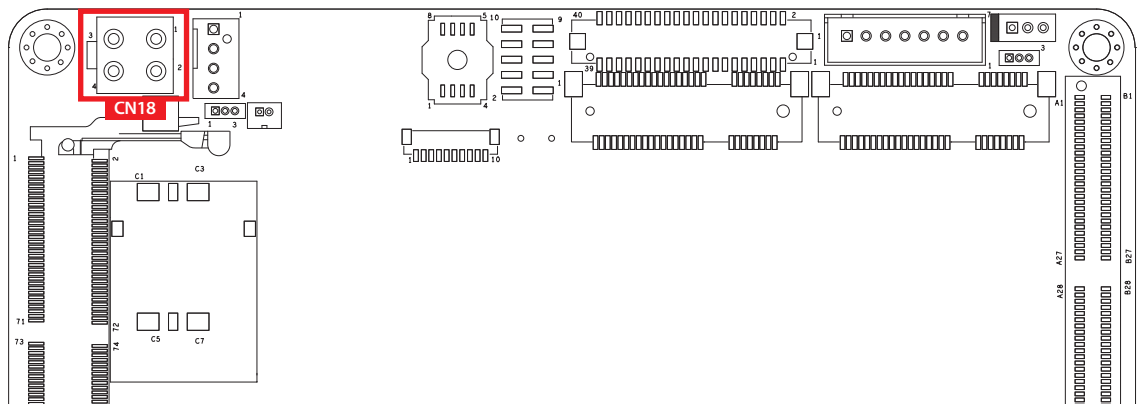

SEC-2000 supports 12V DC power input by wire-to-board connector on the top side.

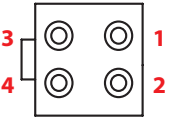
		Pin No.	Definition	Pin No.	Definition
		1	GND	2	GND
		3	+12V	4	+12V



### 2.3.15 CN1, CN2 : SATA III Connector

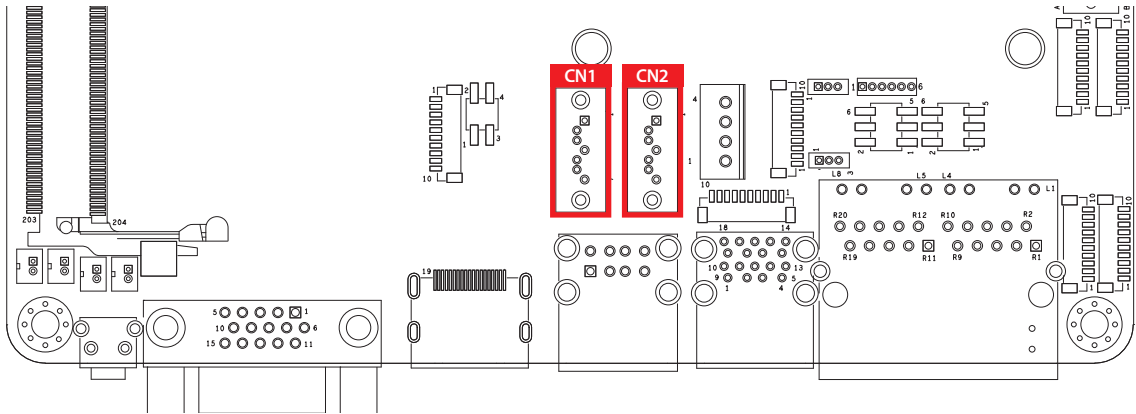

There are 2 onboard high performance Serial ATA III (SATA III) on SEC-2000. It supports higher storage capacity with less cabling effort and smaller required space. CN1 is co-use with CN15, which is selected by jumper JP5. The pin assignments of CN1 and CN2 are listed in the following table :

	Pin No.	Signal Name	Pin No.	Signal Name
	1	GND	2	TXP
	3	TXN	4	GND
	5	RXN	6	RXP
	7	GND		

### 2.3.16 J1 : SATA Power Connector

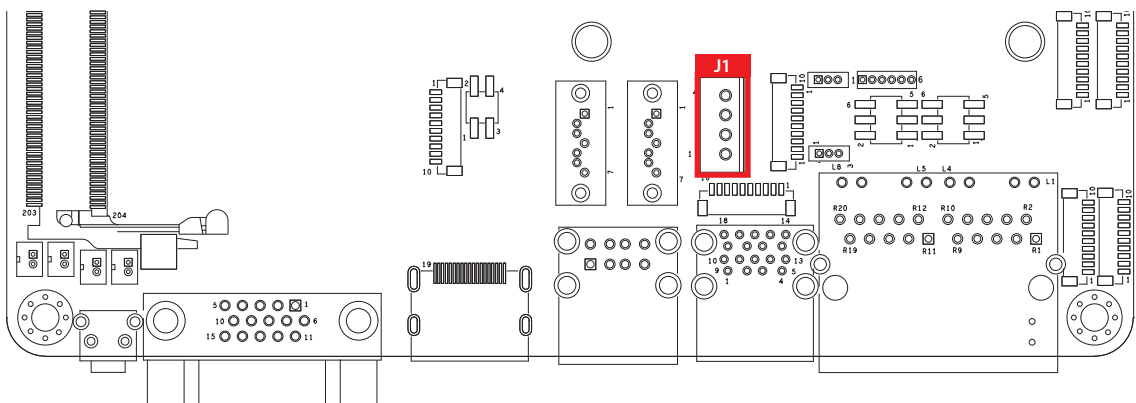

SEC-2000 is also equipped with one SATA power connector. It supports 5V (Up to 2A) and 12V (Up to 1A) current to the hard drive or SSD. The pin assignments of J1 is listed in the following table :

	Pin No.	Signal Name	Pin No.	Signal Name
	1	+12V	2	GND
	3	GND	4	+5V

### 2.3.17 CN16 : Riser PCIe Slot

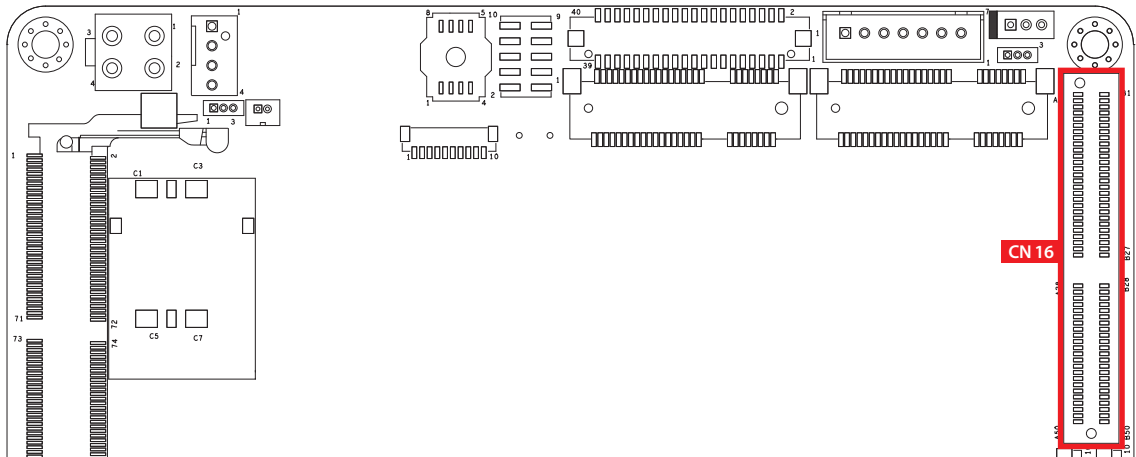

CN16 is used to connect with the riser card. The pin assignments of CN16 is listed in the following table :

Pin No.	Signal Name	Pin No.	Signal Name
A1	P3V3	B1	P3V3
A2	P3V3	B2	P3V3
A3	P3V3	B3	P3V3
A4	N/C	B4	N/C
A5	GND	B5	S_SMB_CLK
A6	GND	B6	S_SMB_DAT
A7	GND	B7	GND
A8	+12V_EN_R	B8	GND
A9	GND	B9	N/C
A10	GND	B10	P3V3_A
A11	BUF_PLTRST_N_A	B11	PCIE_WAKE
A12	GND	B12	GND
A13	CLK_PCIE GF1_DP	B13	GND
A14	CLK_PCIE GF1_DN	B14	PCIE_TXP4
A15	GND	B15	PCIE_TXN4
A16	PCIE_RXP4	B16	GND
A17	PCIE_RXN4	B17	GND

Pin No.	Signal Name	Pin No.	Signal Name
A18	GND	B18	GND
A19	GND	B19	PCIE_TXP5
A20	GND	B20	PCIE_TXN5
A21	PCIE_RXP5	B21	GND
A22	PCIE_RXN5	B22	GND
A23	GND	B23	GND
A24	GND	B24	GND
A25	CLK_PCIE GF2_DP	B25	GND
A26	CLK_PCIE GF2_DN	B26	GND
A27	GND	B27	GND
A28	GND	B28	GND
A29	GND	B29	GND
A30	N/C	B30	N/C
A31	P3V3	B31	P5V
A32	P3V3	B32	P5V
A33	P3V3	B33	P5V
A34	P3V3	B34	P5V
A35	P3V3	B35	P5V
A36	P3V3	B36	P5V
A37	N/C	B37	N/C
A38	GND	B38	GND
A39	GND	B39	GND
A40	USB_D_7P	B40	USB_D_6P
A41	USB_D_7N	B41	USB_D_6N
A42	GND	B42	GND
A43	GND	B43	GND
A44	GND	B44	GND
A45	GND	B45	N/C
A46	N/C	B46	P12V
A47	P12V	B47	P12V
A48	P12V	B48	P12V
A49	P12V	B49	P12V

### 2.3.18 FAN1 : FAN Power Connector

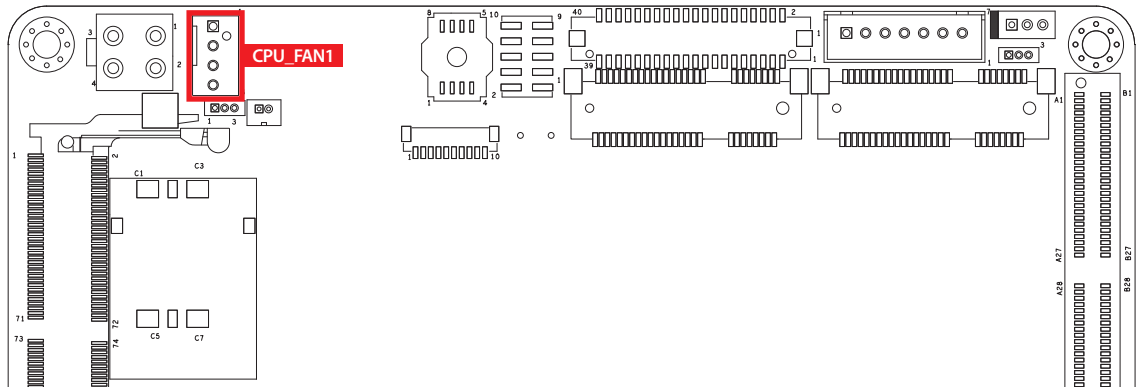

FAN power connector supports for higher thermal requirement.

	Pin No.	Signal Name	Pin No.	Signal Name
	1	GND	2	+12V
	3	FAN_TAC	4	FAN_CTL

### 2.3.19 JPS2 : PS/2 Mouse Keyboard Pin Head

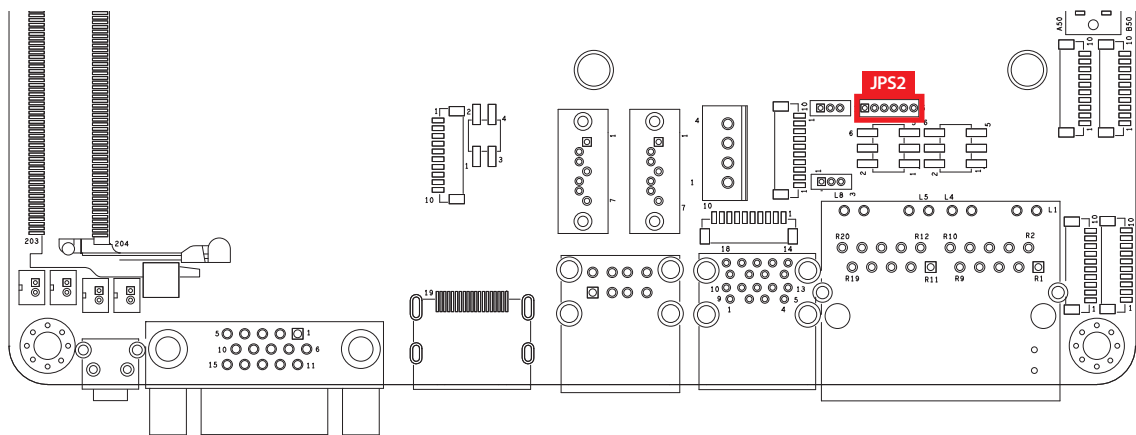

	Pin No.	Signal Name	Pin No.	Signal Name
	1	SIO_MCLK	2	SIO_MDAT
	3	GND	4	SIO_KCLK
	5	SIO_KDAT	6	VCC5_KBMS

### 2.3.20 JDIO1, JDIO2 : GPIO

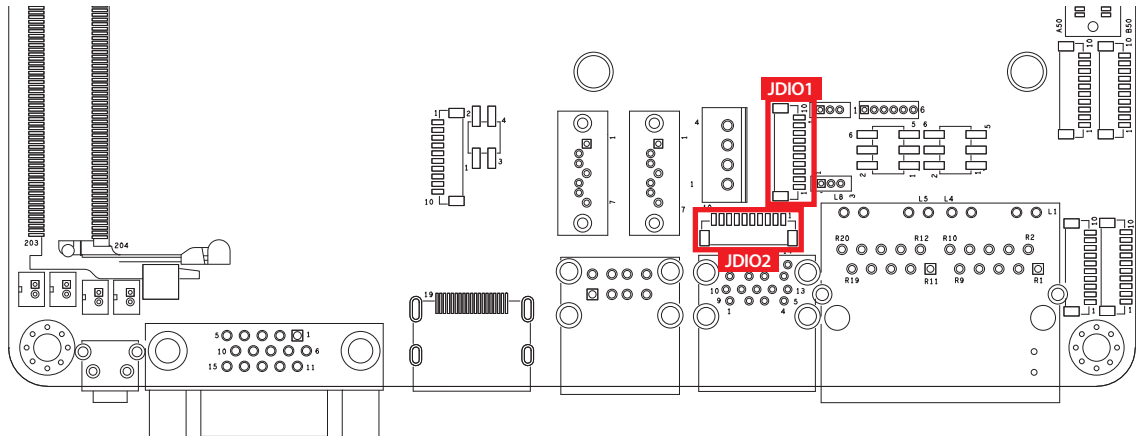

There is a 16-bit GPIO connector on the top side. Each GPIO channel can be configured into GPI or GPO. Please refer to below table to see the pin definition in details. JDIO1 and JDIO2 Pin define are as below.

Pin No.	JDIO1 Definition	JDIO2 Definition
1	SIO_GPO70	SIO_GPI80
2	SIO_GPO71	SIO_GPI81
3	SIO_GPO72	SIO_GPI82
4	SIO_GPO73	SIO_GPI83
5	SIO_GPO74	SIO_GPI84
6	SIO_GPO75	SIO_GPI85
7	SIO_GPO76	SIO_GPI86
8	SIO_GPO77	SIO_GPI87
9	+3.3V	+3.3V
10	GND	GND

### 2.3.21 Bottom Side

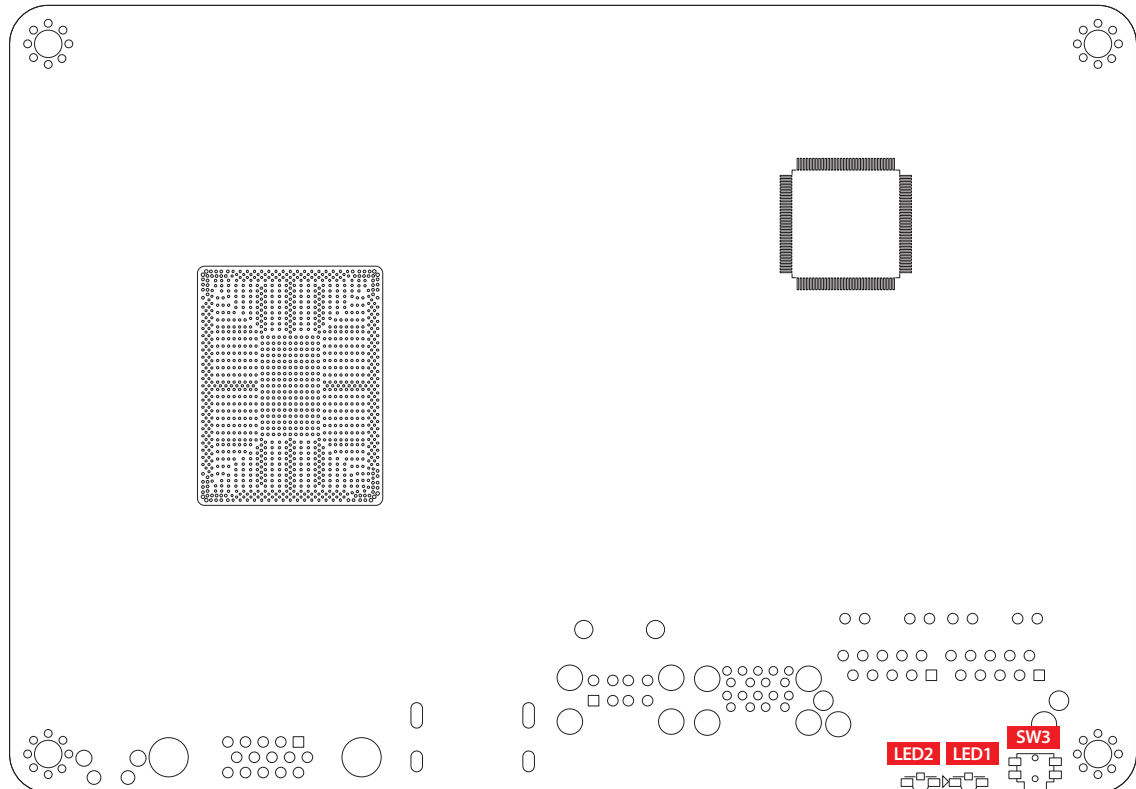

### 2.3.22 PWR and HDD LED Indicator

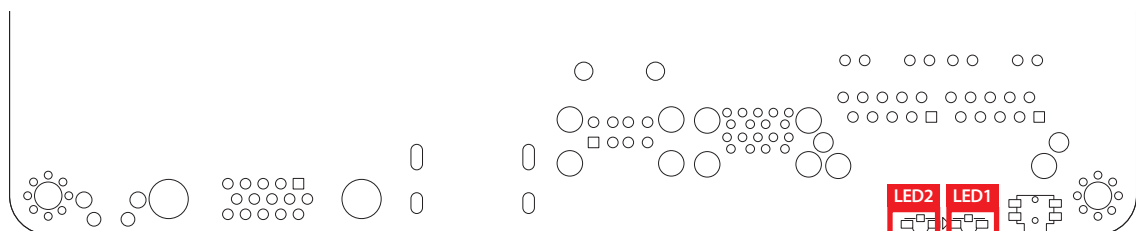

**Power LED (LED1) :** If the LED is solid green, it indicates that the system is powered on.

**HDD LED (LED2) :** If the LED is on, it indicates that the system's storage is functional. If it is off, it indicates that the system's storage is not functional. If it is flashing, it indicates data access activities.

LED Color	Indication	System Status
Orange	HDD	On/Off : Storage status, function or not. Twinkling : Data transferring.
Green	Power	System power status (On/Off)

### 2.3.23 Reset Tact Switch

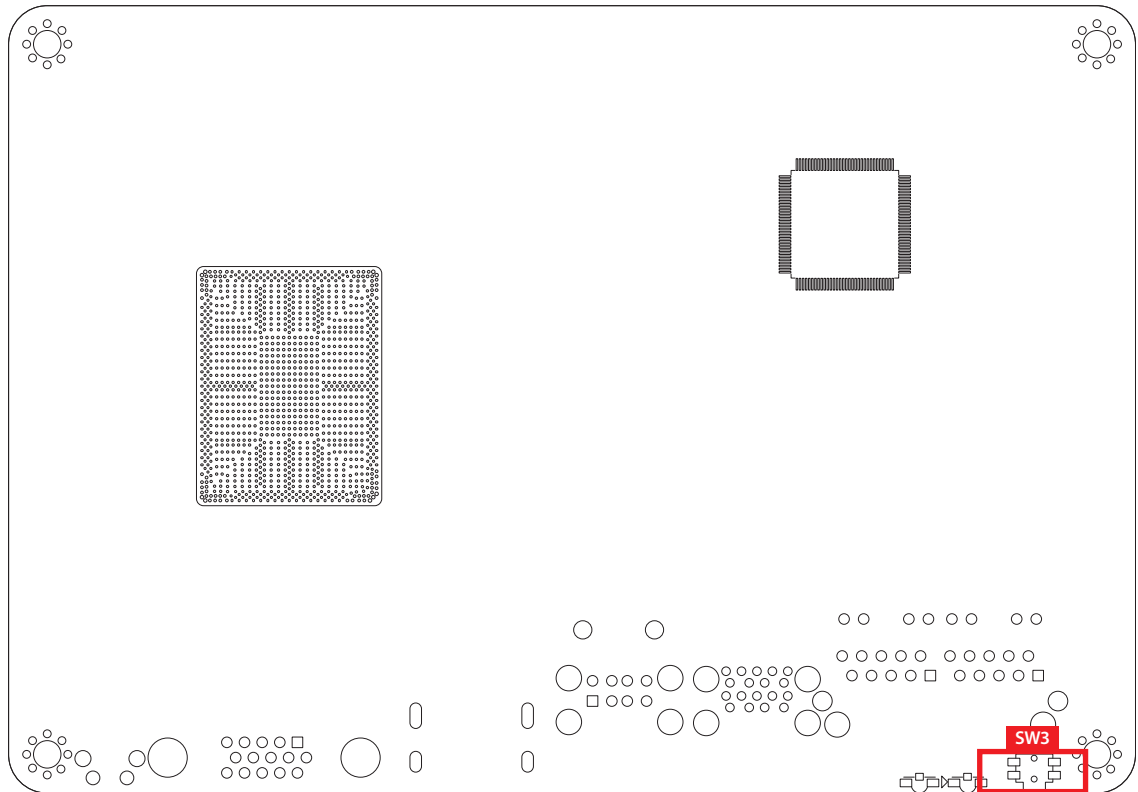

It is a hardware reset switch. Use this switch to reset the system without power off the system. Press the Reset Switch for a few seconds, and then reset will be enabled.

## 2.4 Main Board Jumper Settings

### 2.4.1 Front View of SEC-2000 Main Board With Jumper Location

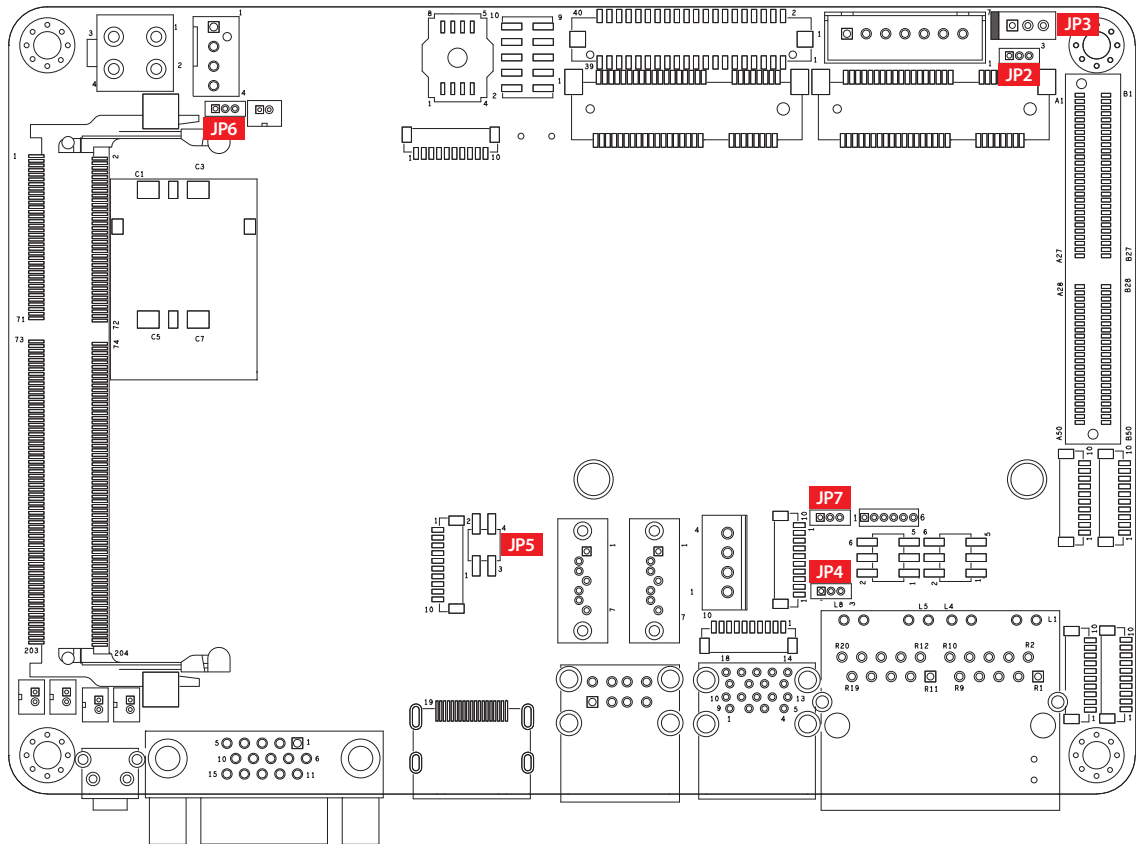

### 2.4.2 JP3 : LVDS Module, Power Selection

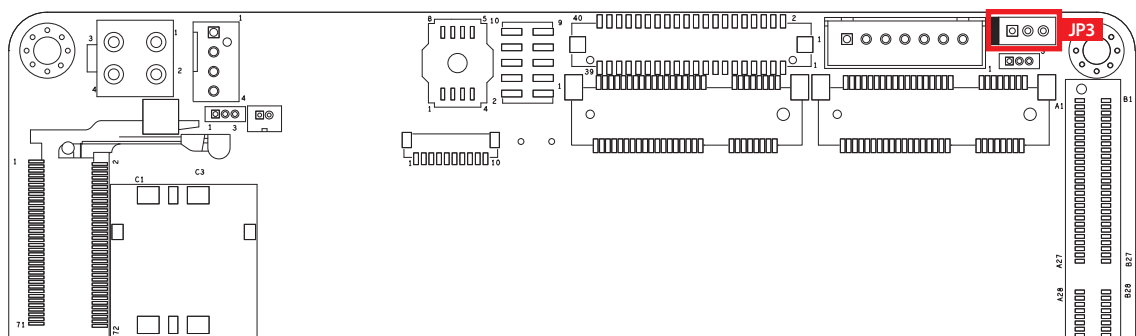

JP3 provides LVDS voltage selection function, closing Pin 1, 2 is for 3.3V LVDS power input; closing Pin 2, 3 is for 5V LVDS power input.

	Pin No.	Function
	1-2	+3.3V (Default)
	2-3	+5V



### 2.4.3 JP6 : CMOS

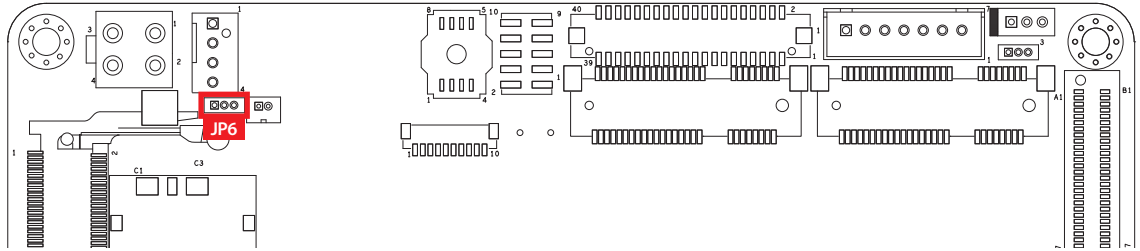

	Pin No.	Function
	1-2	Normal (Default)
	2-3	Clear CMOS

### 2.4.4 JP5 : CN13 mSATA/Mini PCIe; CN1 SATA/NC select

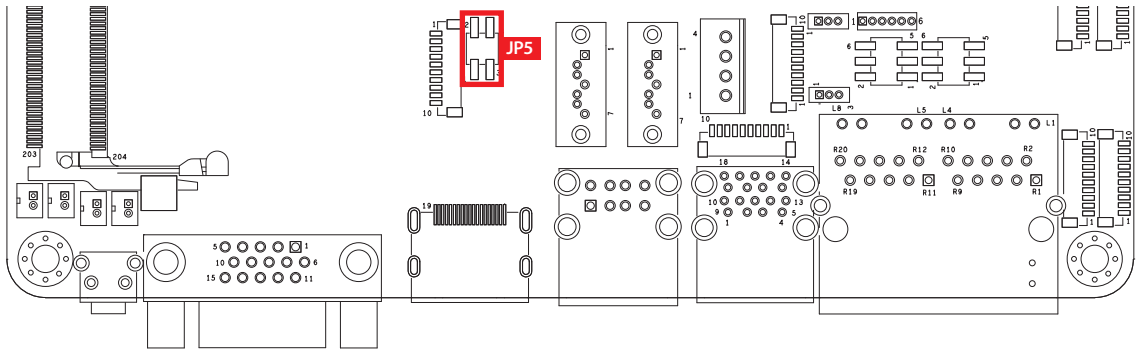

	Pin No.	CN15	CN1
	1-3/2-4	mSATA	N/C
	N/C	Mini PCIe (Default)	SATA (Default)

### 2.4.5 JP2 : Backlight Control Level Select

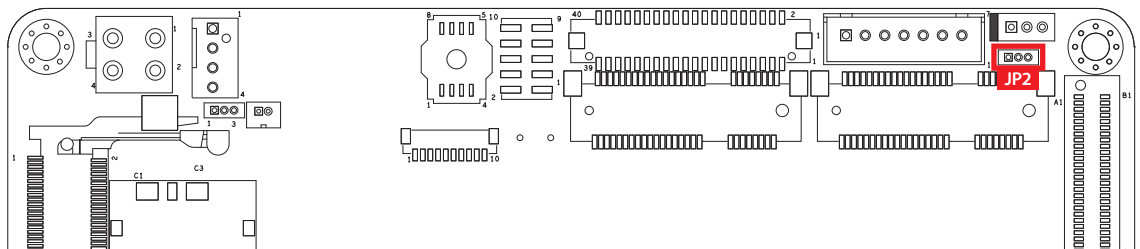

JP2 provides LVDS backlight control selection function, closing Pin 1, 2 is for 3.3V and closing Pin 2, 3 is for 5V

	Pin No.	Function
	1-2	+3.3V (Default)
	2-3	+5V

## 2.4.6 JP4 : USB Power Select

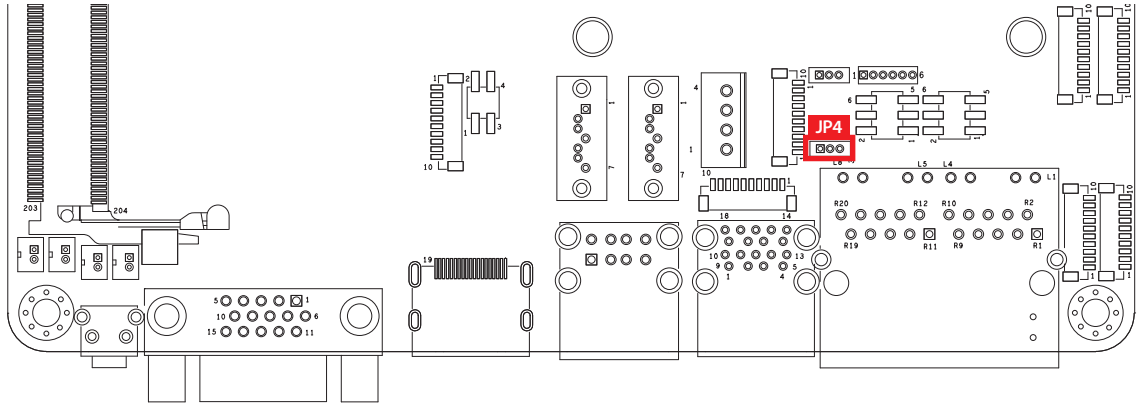

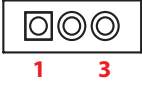
	Pin No.	Function
	1-2	+5V Standby Power (Default)
	2-3	+5V System Power

## 2.4.7 JP7 : GPI Signal Pull High Power Rail Select

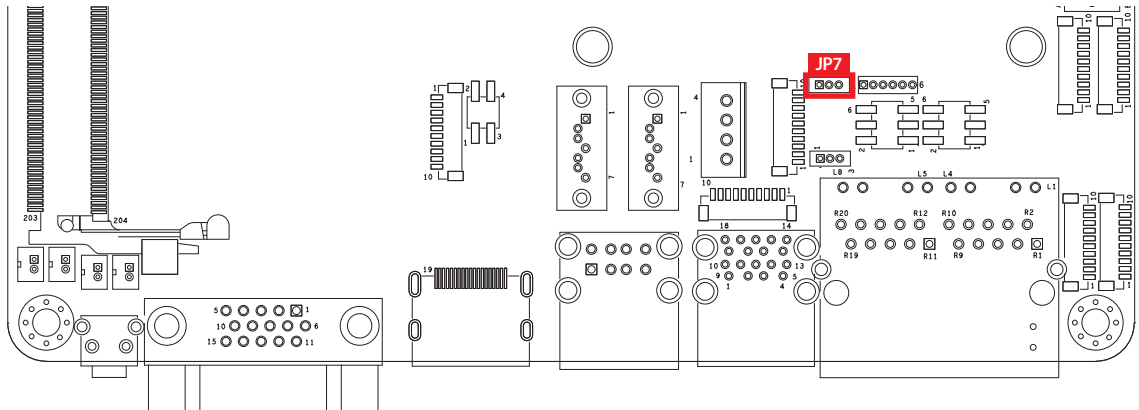

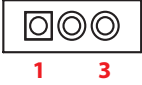
	Pin No.	SIO_GPI80 to SIO_GPI87
	1-2	Pull high to P3V3_A (Default)
	2-3	Hi-Z

# 3

## SETUP

### 3.1 How to Open Your SEC-2000

**Step 1** Please place your SEC-2000 like this.



**Step 2** Remove eight PHILLIPS M3 screws.

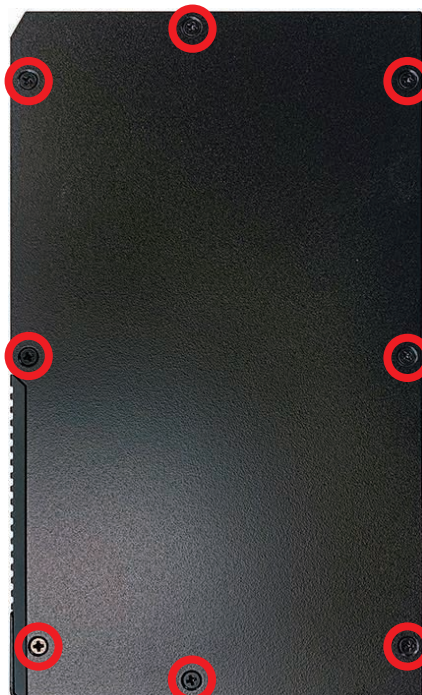

**Step 3** Please place the system like below image.

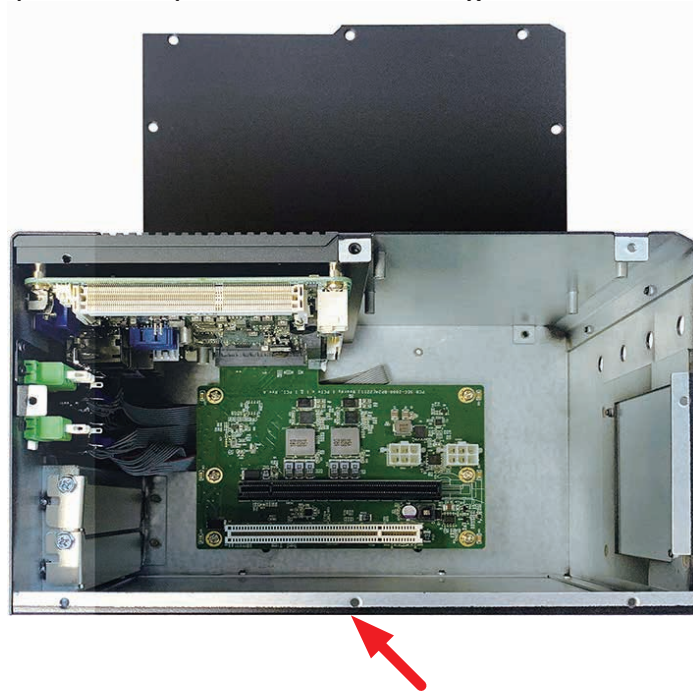

**Step 4** Remove six PHILLIPS M3 screws.

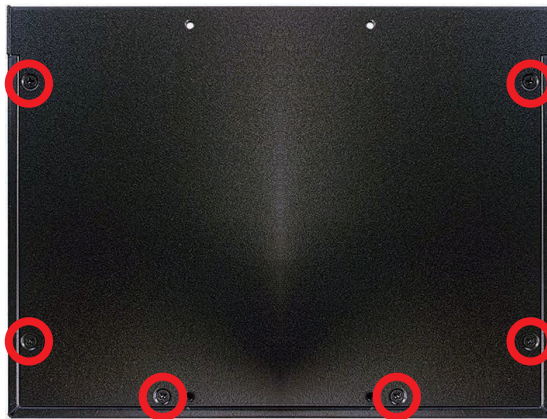

**Step 5** Finish.

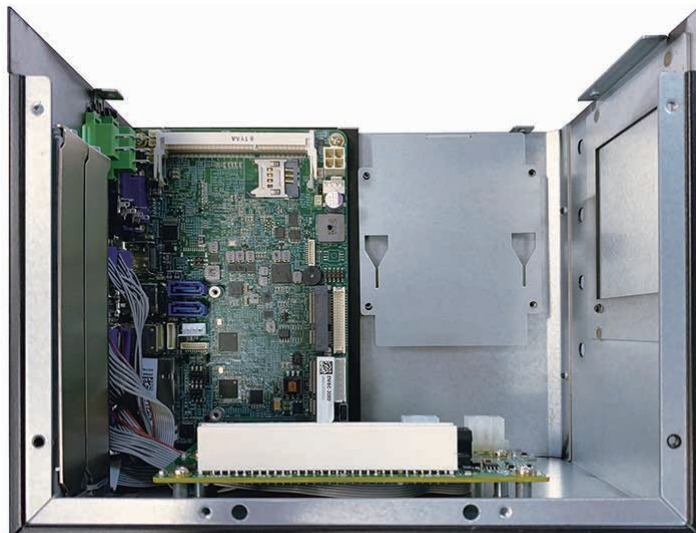

## 3.2 Installing DDR3L Module

**Step 1** Find DDR3L SO-DIMM socket. (Note : only Non-ECC supported)

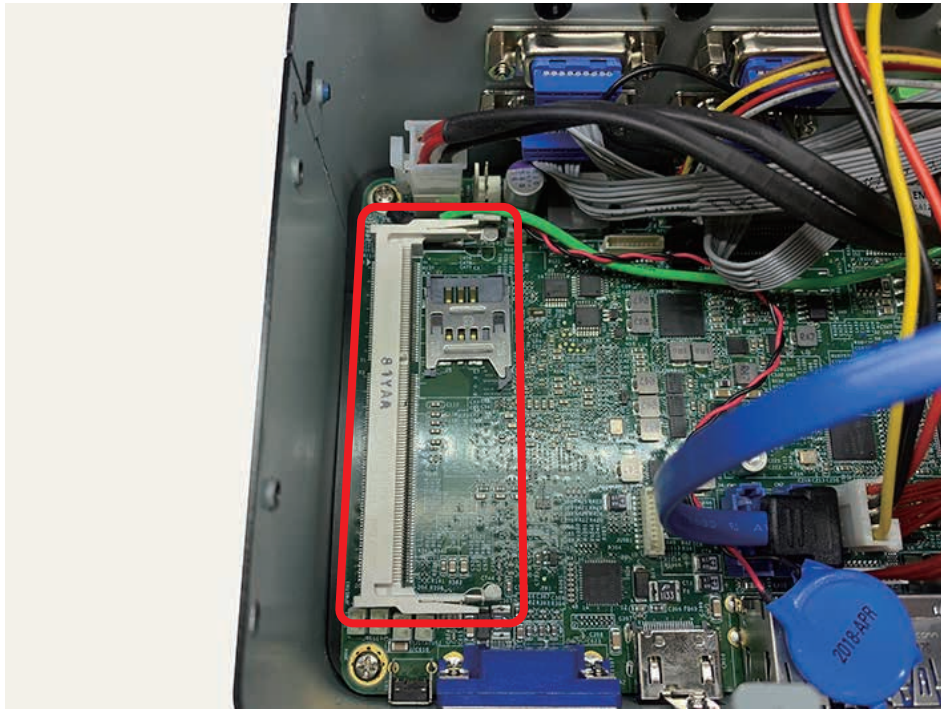

**Step 2** Install DDR3L RAM module into SO-DIMM socket.

**Step 3** Finished.



### 3.3 Installing Mini PCIe Card

Step 1 Find Mini PCIe socket.

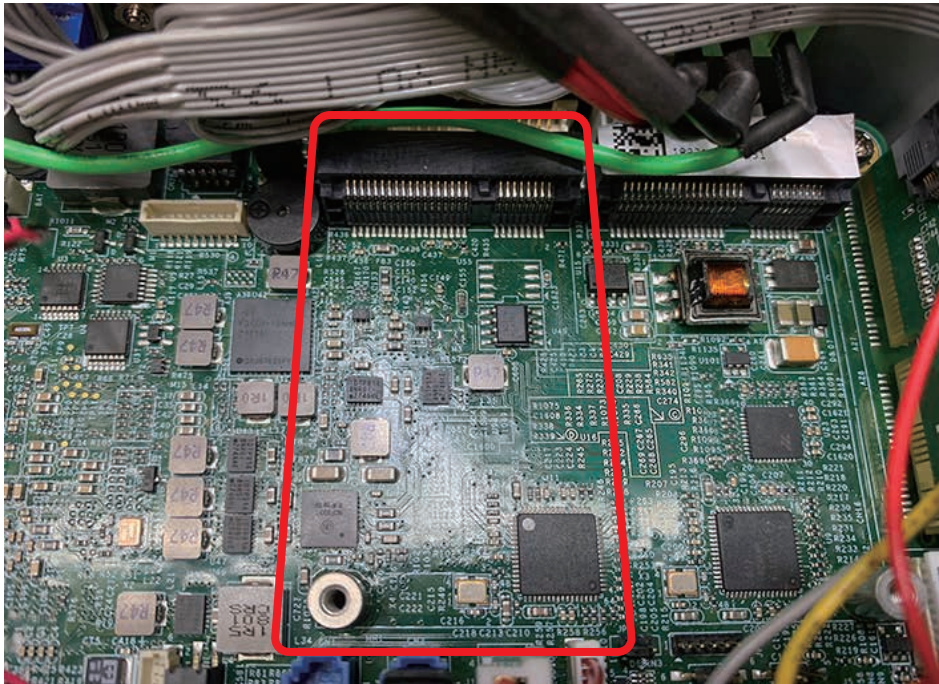

Step 2 Install Mini PCIe card into socket.



Step 3 Fasten a PHILLIPS M2.5 screw.



### 3.4 Installing Antenna Cable

**Step 1** Check antenna cable, washer and nut.



**Step 2** Install antenna cable and then fasten washer and nut.

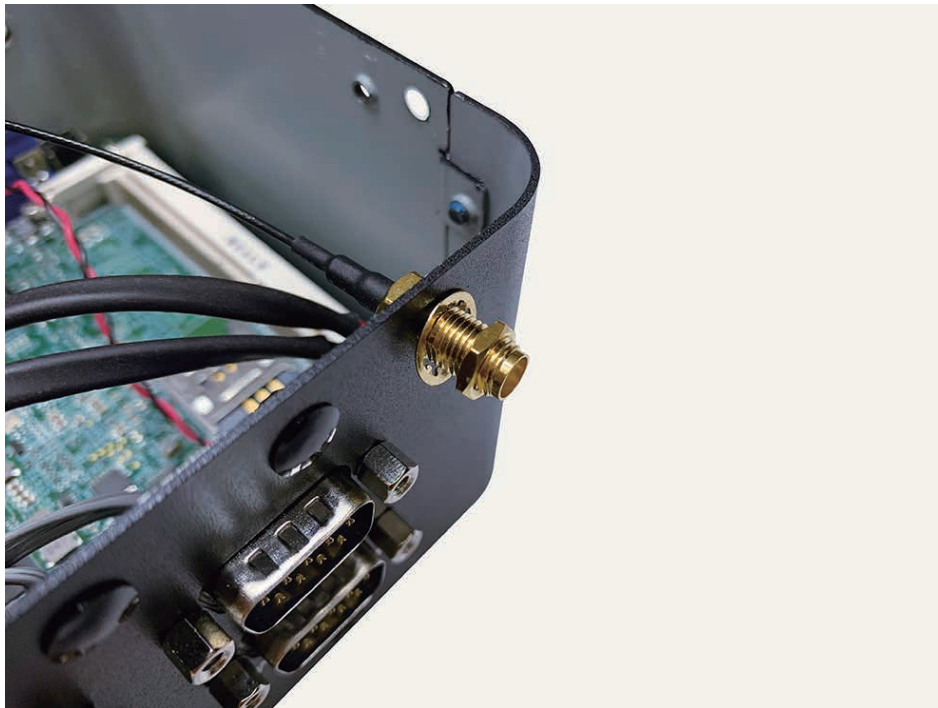

### 3.5 Installing SIM Card

**Step 1** Push SIM card slot cover to open.

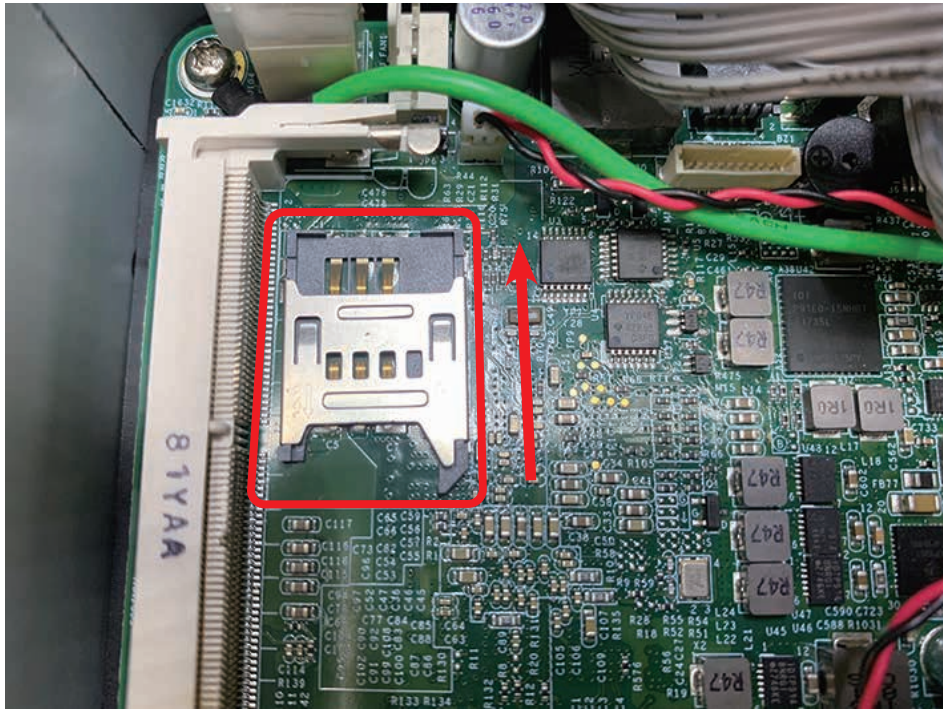

**Step 2** Open situation.

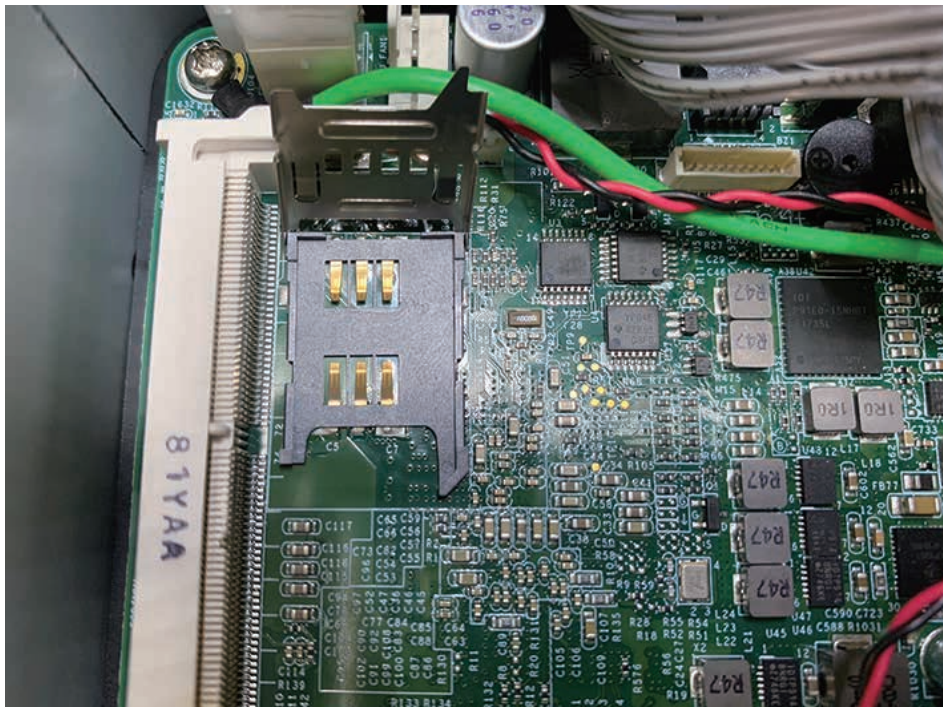



**Step 3** Install SIM card and close the cover.

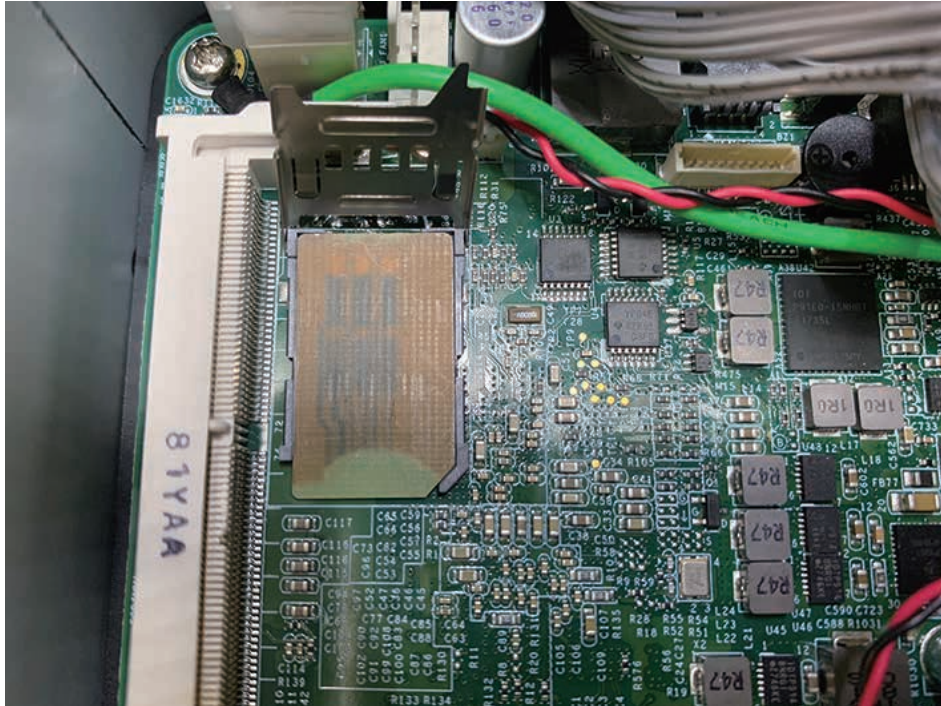

**Step 4** Finish.

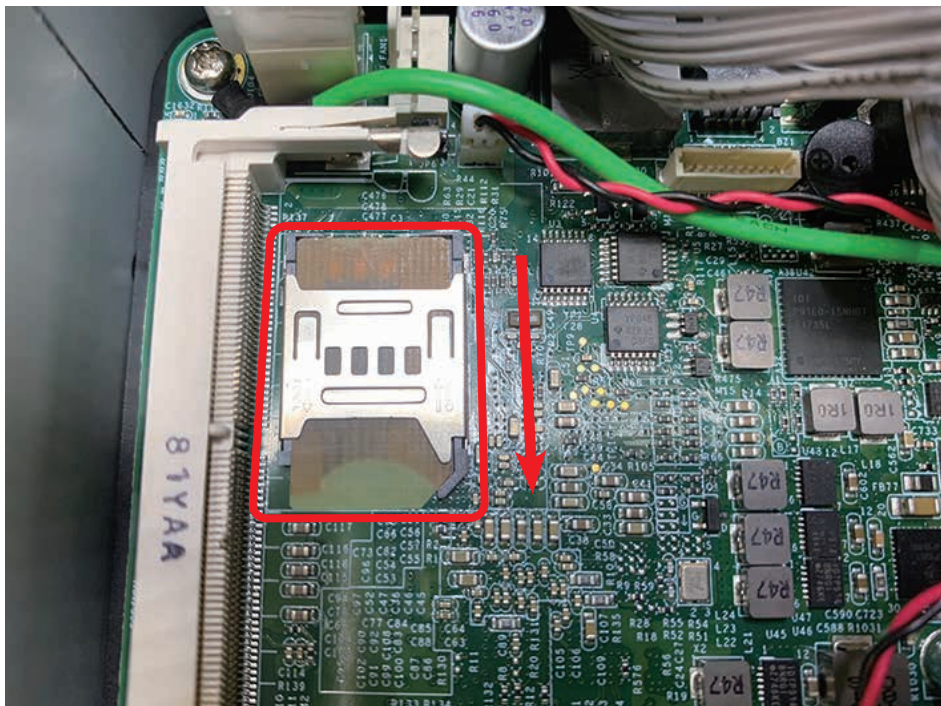

## 3.6 Installing SSD/HDD

**Step 1** Remove one PHILLIPS M3x6L screw and SSD/HDD bracket.

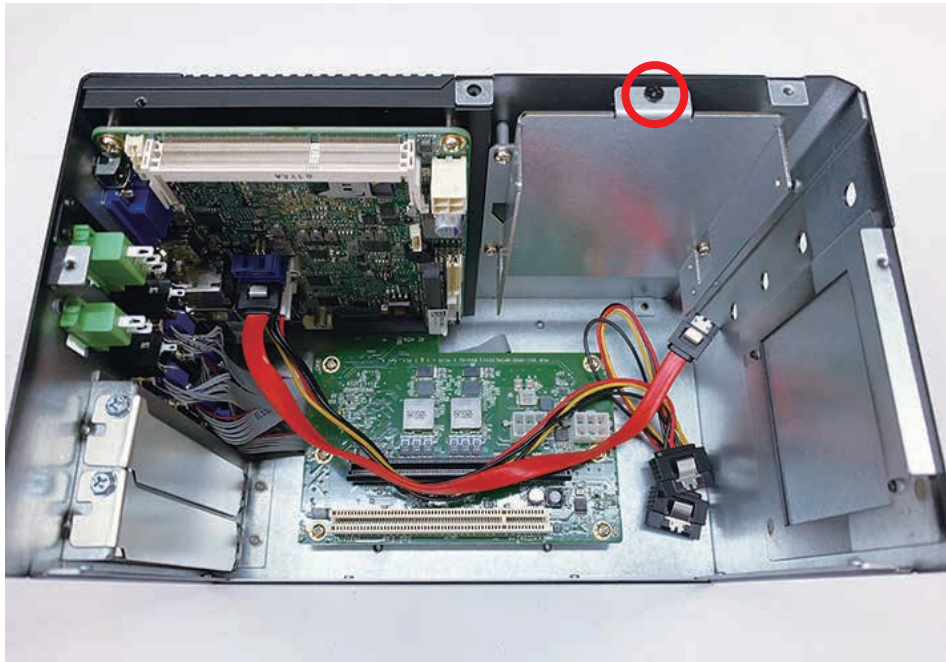

**Step 2** Remove SSD/HDD bracket.



**Step 3** Fasten four PHILLIPS M3x6L screws.

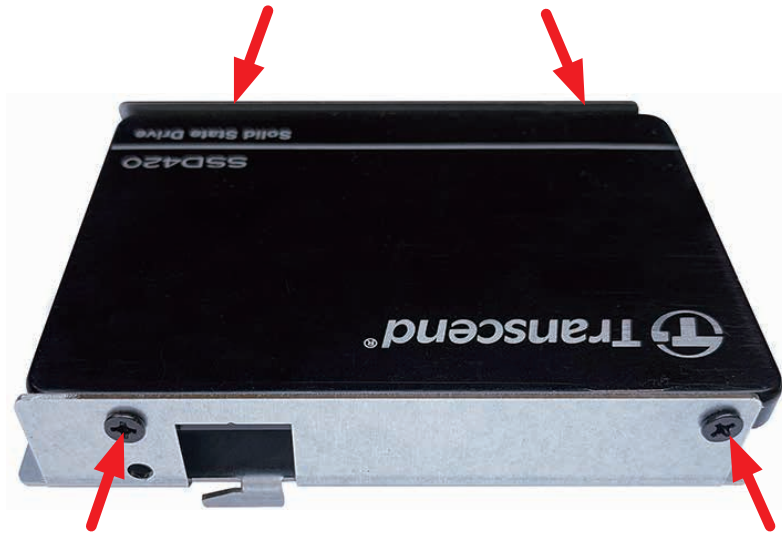

**Step 4** Connect SATA cable and SATA power cable to SSD/HDD.

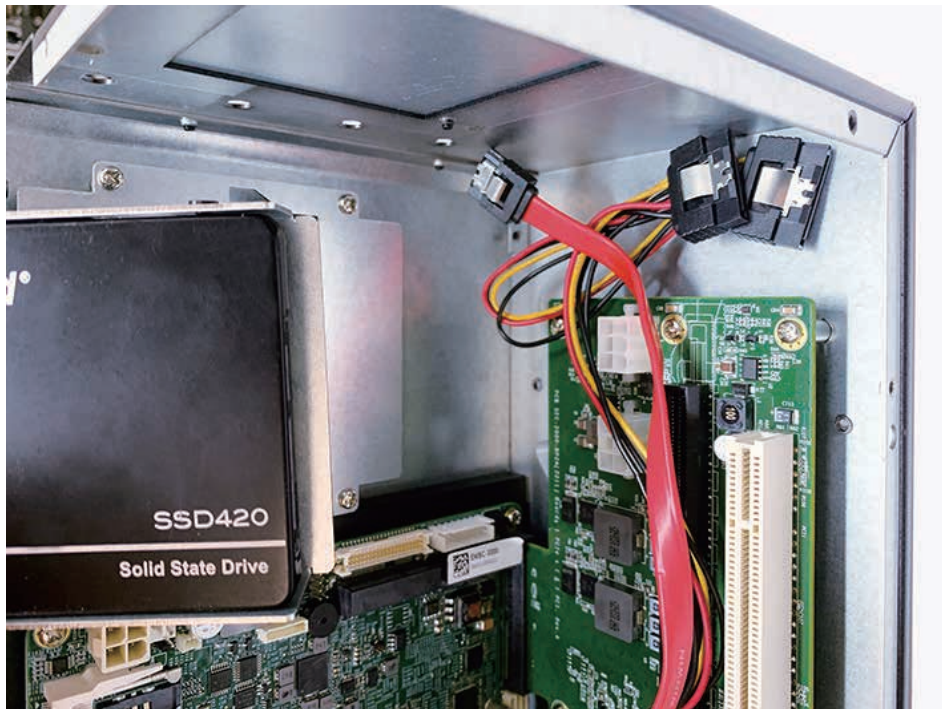

**Step 5** Finish connect cable and install bracket with latch.



**Step 6** Install the bracket and then fasten one PHILLIPS M3x6L screw.

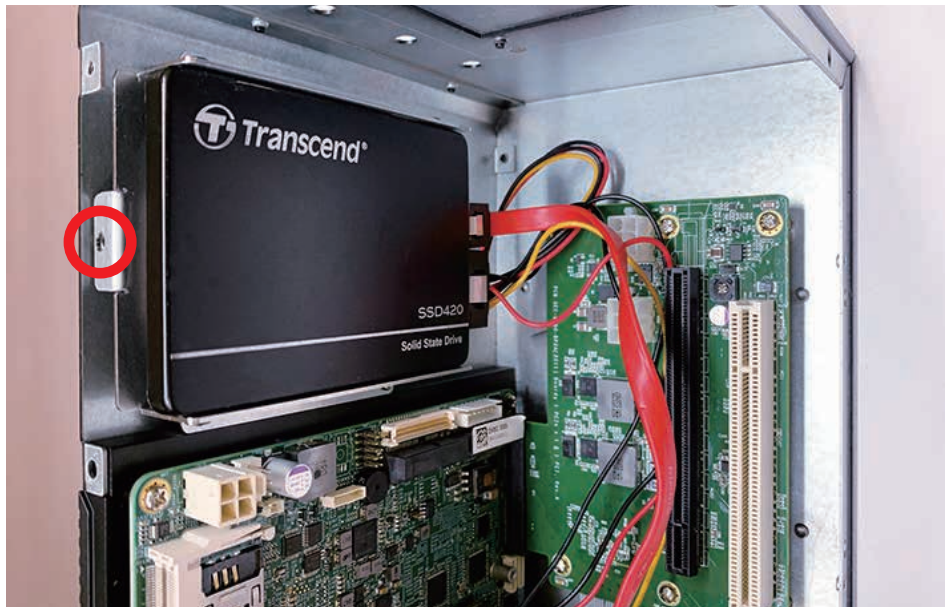

## 3.7 Installing PCI/PCIe Card

**Step 1** Remove one PHILLIPS M3 screw.

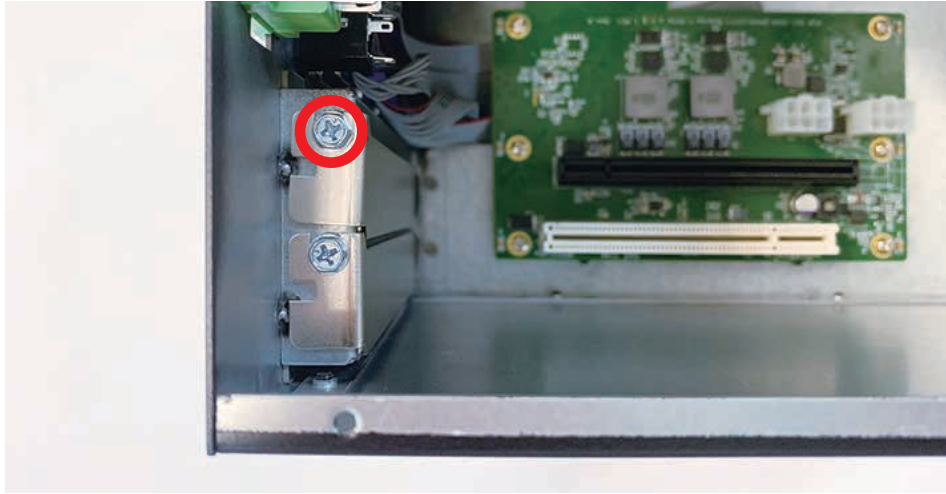

**Step 2** Install PCI/PCIe Card with slot.

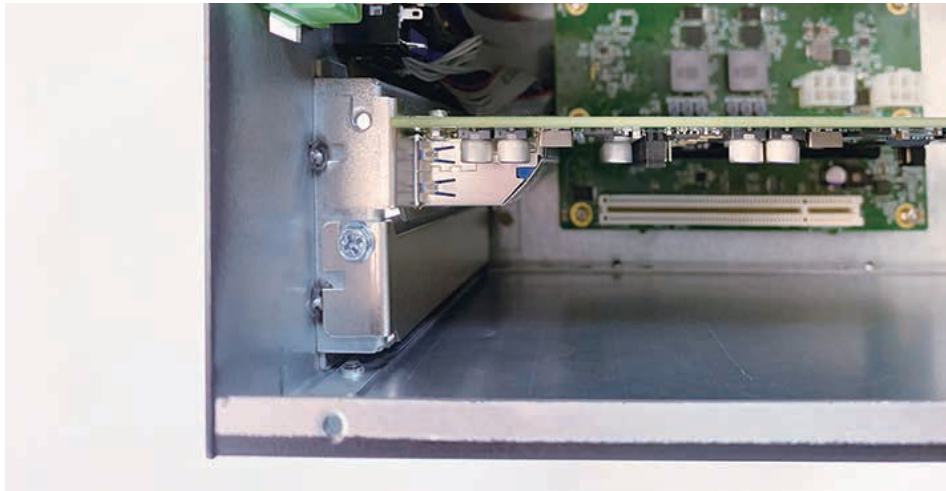

**Step 3** Fasten one PHILLIPS M3 screw.

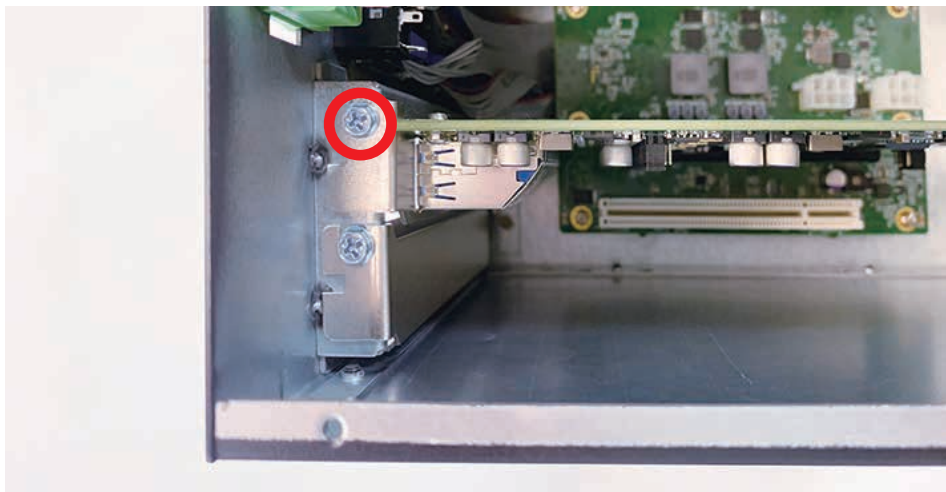

## 3.8 Mounting Your SEC-2000

### 3.8.1 Wall Mount

Fasten four PHILLIPS M3 screws.

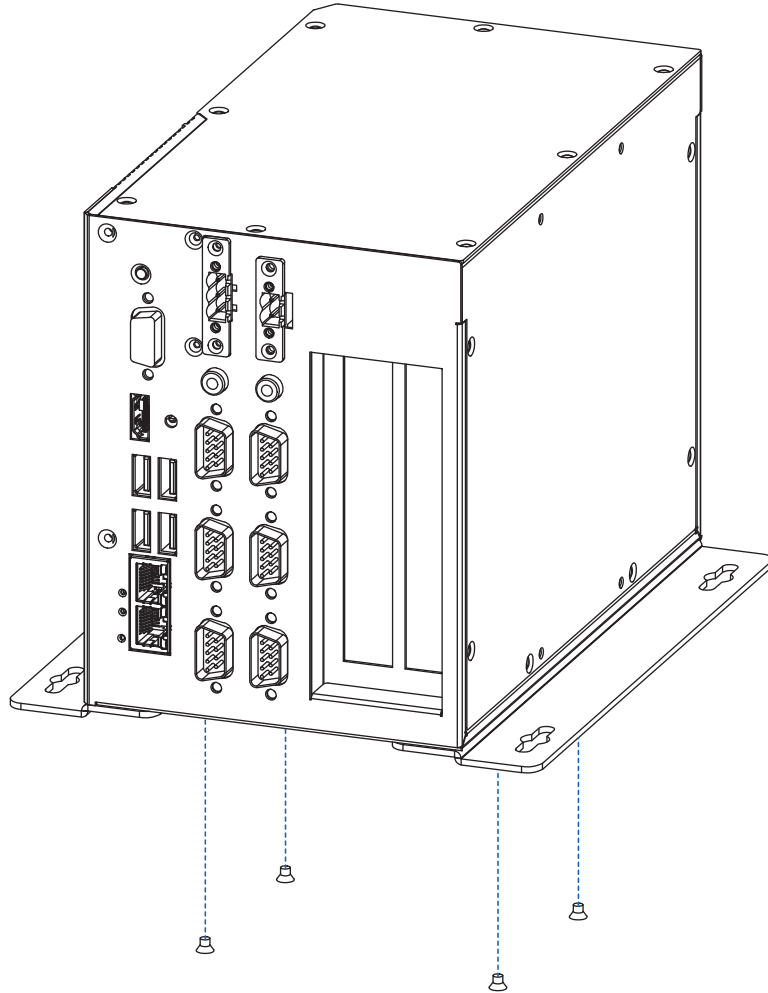

# 4

## BIOS SETUP

### 4.1 Entering Setup

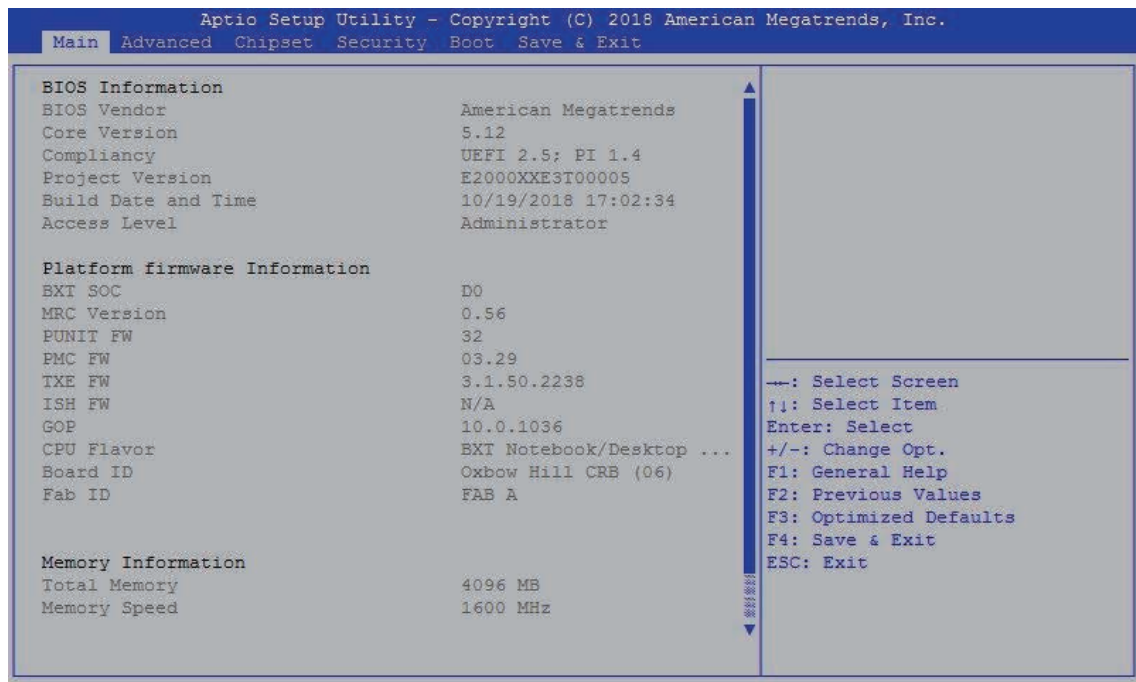

Figure 4-1 : Entering Setup Screen

BIOS provides an interface for users to check and change system configuration. The BIOS setup program is accessed by pressing the <Del> key when POST display output is shown.

## 4.2 Main Menu

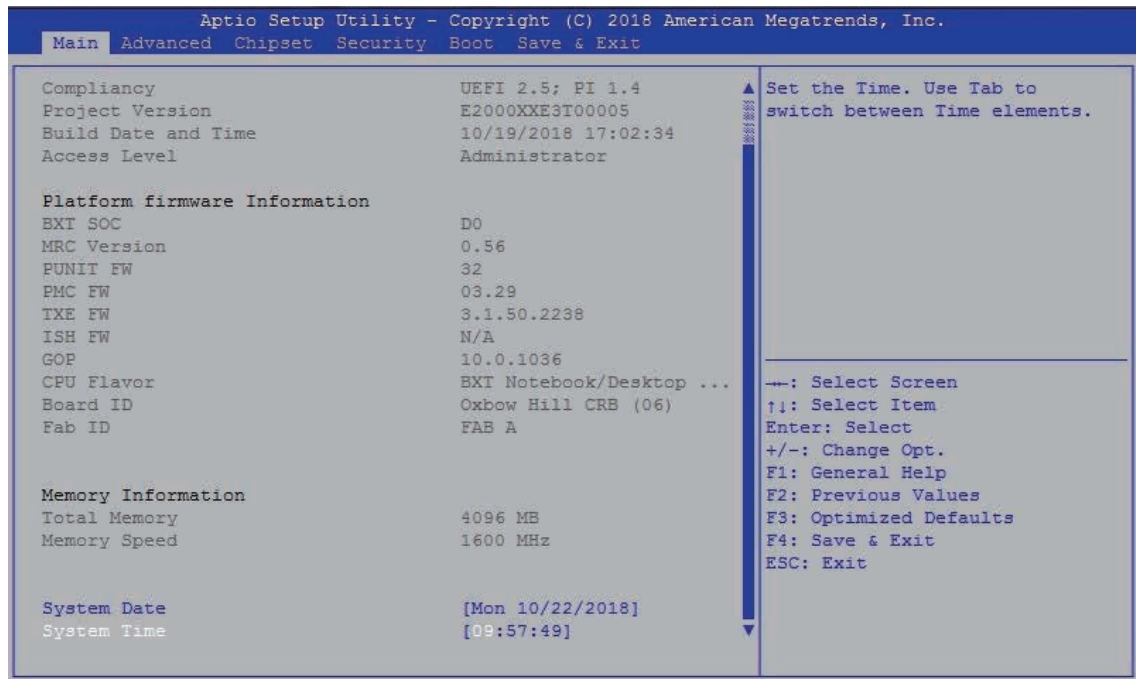

Figure 4-2 : BIOS Main Menu

The Main menu displays BIOS version and system information. There are two options on Main menu.

### System Data

Set the date. Use <Tab> to switch between date elements.

### System Time

Set the time. Use <Tab> to switch between time elements.

## 4.3 Advanced

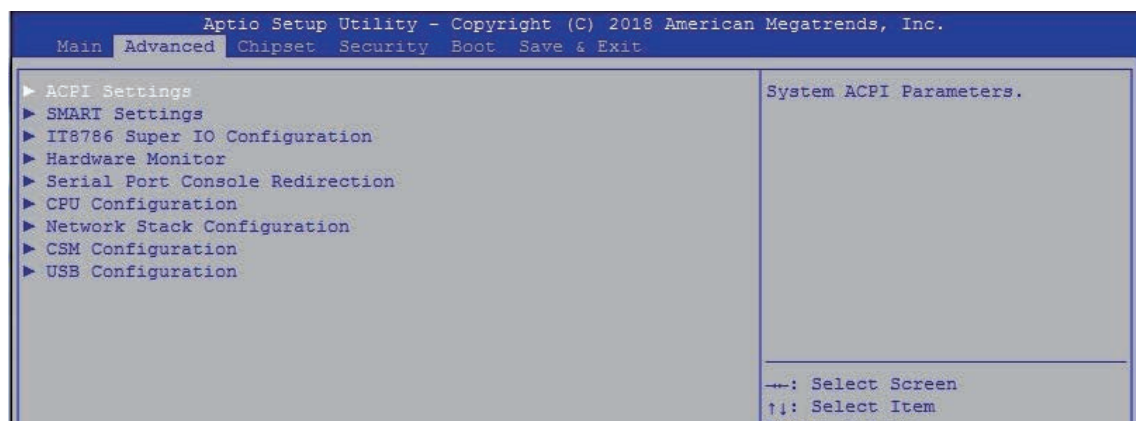

Figure 4-3 : BIOS Advanced menu

Select advanced tab to enter advanced BIOS setup options, such as CPU configuration, Network configuration, and USB configuration.



### 4.3.1 ACPI Settings



Figure 4-3-1 : ACPI Settings

#### Enable Hibernation

Enables or Disables System ability to Hibernate (OS/S4 Sleep State). This option may be not effective with some OS.

#### ACPI Sleep State

Select the highest ACPI sleep state the system will enter when the SUSPEND button is pressed.

### 4.3.2 SMART Settings

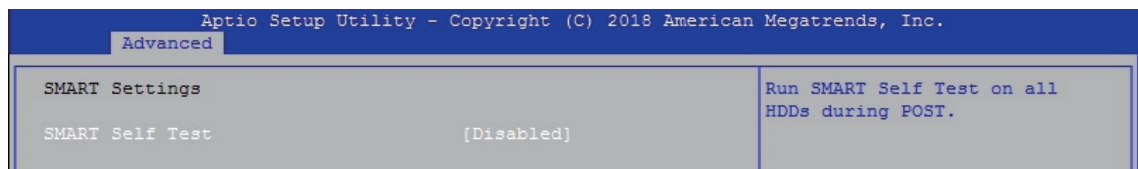

Figure 4-3-2 : SMART Settings

#### SMART Self Test

Run SMART Self Test on all HDDs during POST.

### 4.3.3 IT8786 Super IO Configuration

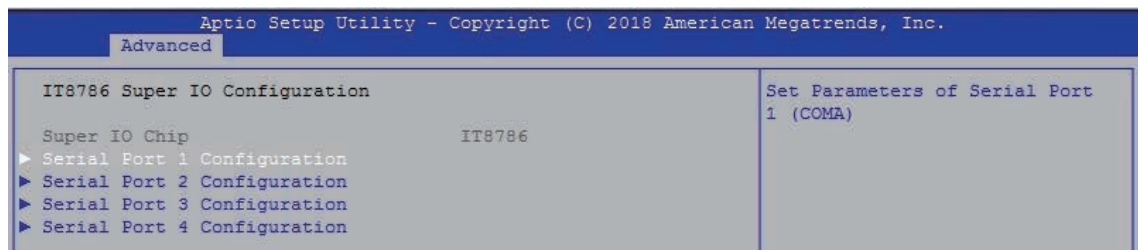

Figure 4-3-3-1 : Super IO Settings

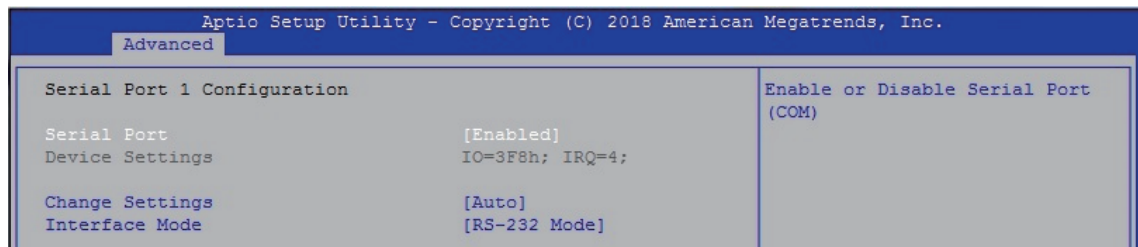

Figure 4-3-3-2 : Super IO Serial Port Configuration

#### Serial Port 1 to Port 4 Configuration

Options for Serial Port 1 to Serial Port 4.

Entering the corresponding Port option then end user can change the settings such as I/O resource and UART mode.

### 4.3.4 Hardware Monitor

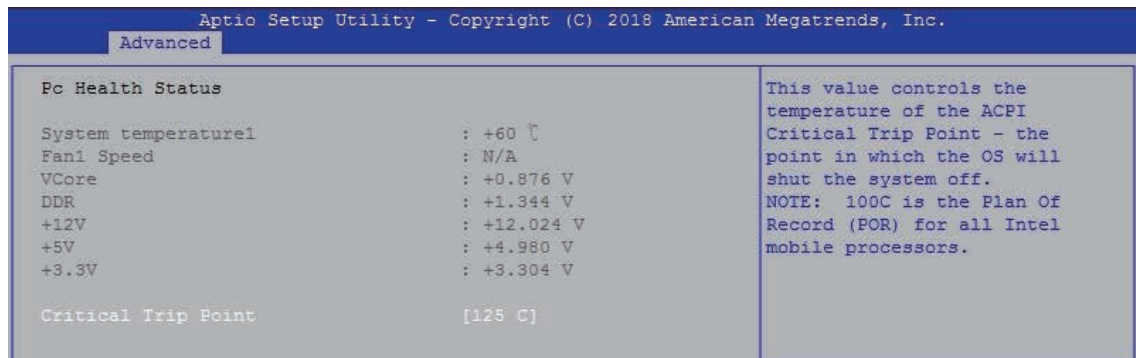

Figure 4-3-4 : Hardware Monitor Settings

The IT8786 SIO features an enhanced hardware monitor providing thermal, fan speed, and system voltage's status monitoring.

#### Critical Trip Point

This value controls the temperature of the ACPI Critical Trip Point - the point in which the OS will shut the system off.

### 4.3.5 Serial Port Console Redirection



Figure 4-3-5 : Serial Port Console Redirection Settings

#### Console Redirection

Console Redirection Enable or Disable.

#### Console Redirection Settings

The settings specify how the host computer and the remote computer (which the user is using) will exchange data. Both computers should have the same or compatible settings.

#### Legacy Console Redirection

Legacy Console Redirection Settings.

#### Serial Port for Out-of-Band Management/Windows Emergency Management Services (EMS)

Console redirection enable or disable.

### 4.3.6 CPU Configuration

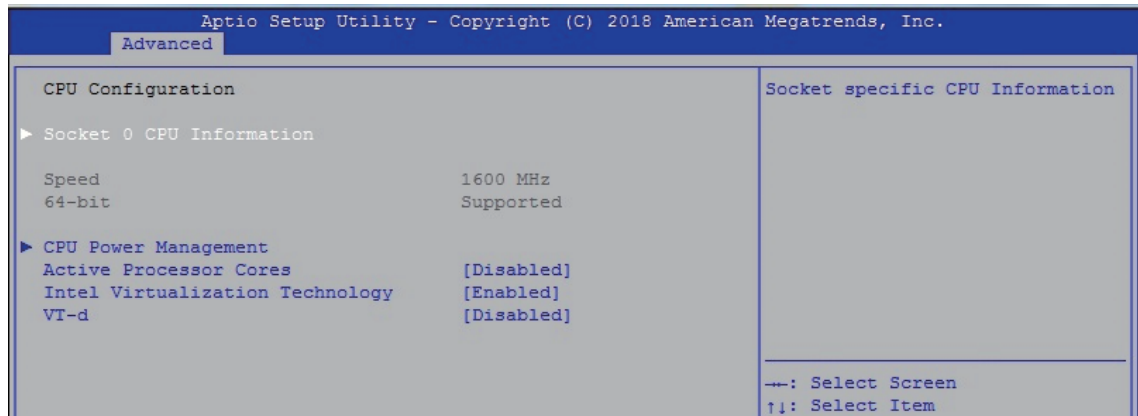

Figure 4-3-6-1 : CPU Configuration

#### Active Processor Cores

Enable this to disable core in each processor package.

#### Intel Virtualization Technology

When enabled, a VMM can utilize the additional hardware capabilities provided by Vanderpool Technology.

#### VT-d

Enable/Disable CPU VT-d.

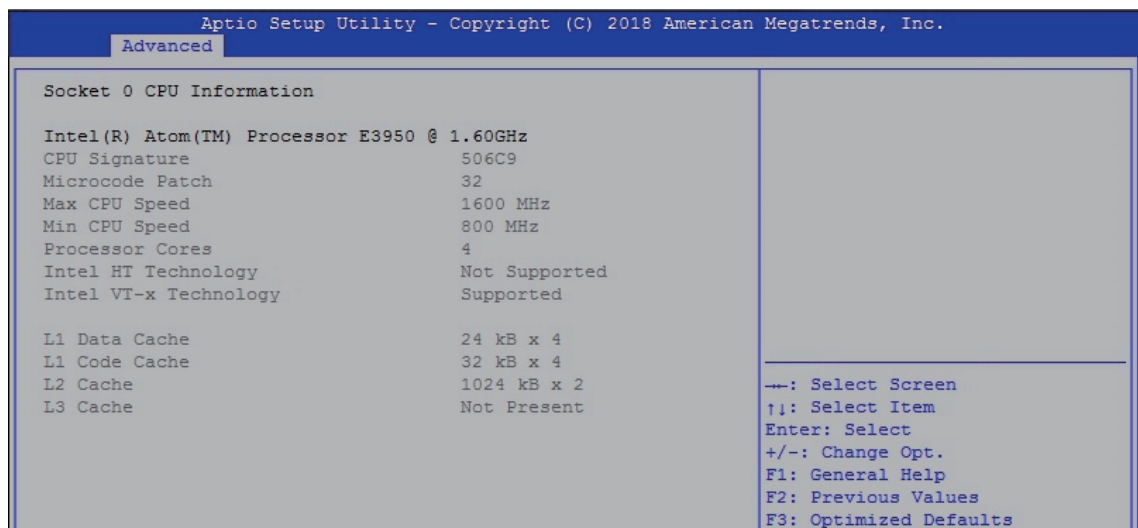

Figure 4-3-6-2 : CPU Information

Socket Specific CPU Information.

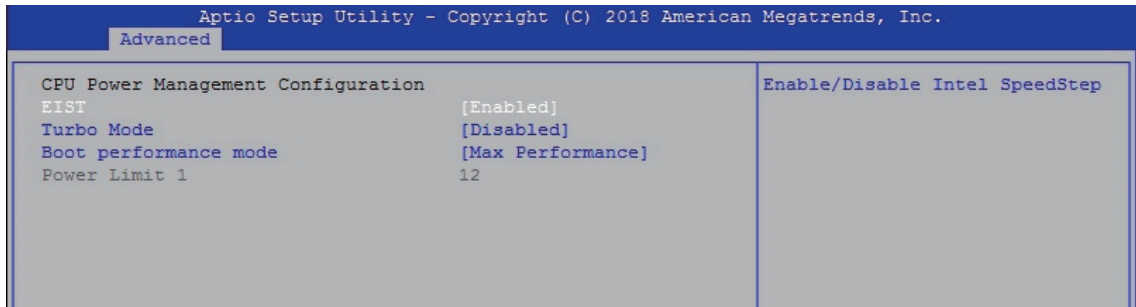

Figure 4-3-6-3 : CPU Power Management

### EIST

Enable/Disable Intel SpeedStep.

### Turbo Mode

Turbo Mode.

### Boot performance mode

Select the performance state that the BIOS will set before OS handoff.

## 4.3.7 Network Stack Configuration



Figure 4-3-7 : Network Stack Settings

### Network Stack

Enable/Disable UEFI Network Stack.

### Ipv4 PXE Support

Enable Ipv4 PXE Boot Support. If disabled IPV4 PXE boot option will not be created.

### Ipv6 PXE Support

Enable Ipv6 PXE boot Support. If disabled IPV6 PXE boot option will not be created.

### PXE boot wait time

Wait time to press ESC key to abort the PXE boot.

### Media detect count

Number of times presence of media will be checked.

## 4.3.8 CSM Configuration

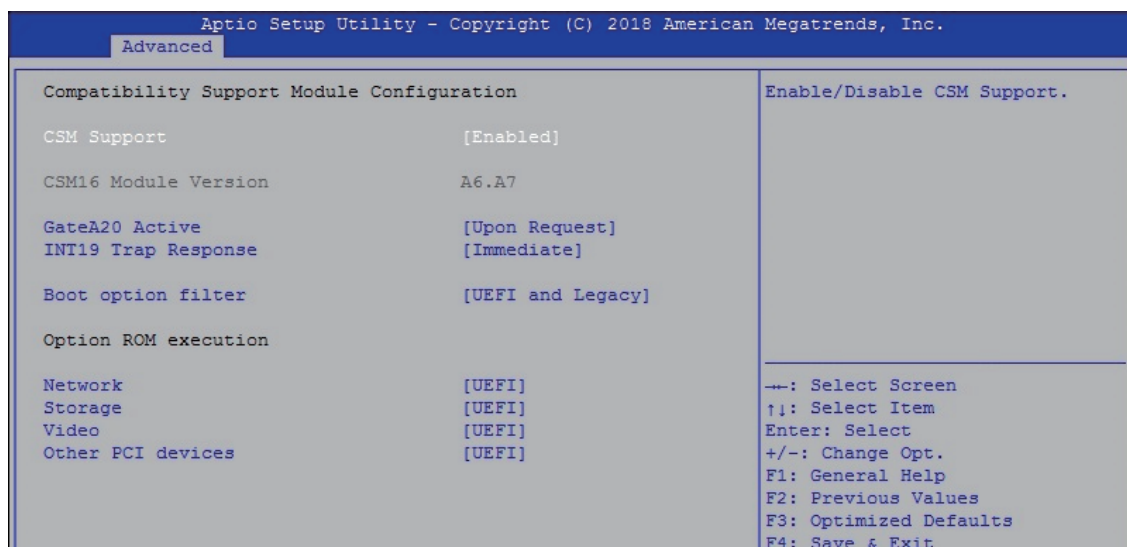

Figure 4-3-8 : CSM Settings

### CSM Support

Enable/Disable CSM support.

### GateA20 Active

UPON REQUEST - GA20 can be disabled using BIOS services. ALWAYS - do not allow disabling GA20; this option is useful when any RT code is executed above 1MB.

### INT19 Trap Response

BIOS reaction on INT19 trapping by Option ROM : IMMEDIATE - execute the trap right away; POSTPONED - execute the trap during legacy boot.

### Boot option filter

This option controls Legacy/UEFI ROMs priority.

### Network

Controls the execution of UEFI and Legacy PXE OpROM.

### Storage

Controls the execution of UEFI and Legacy Storage OpROM.

### Video

Controls the execution of UEFI and Legacy Video OpROM.

### Other PCI devices

Determines OpROM execution policy for devices other than Network, Storage, or Video.

## 4.4 Chipset

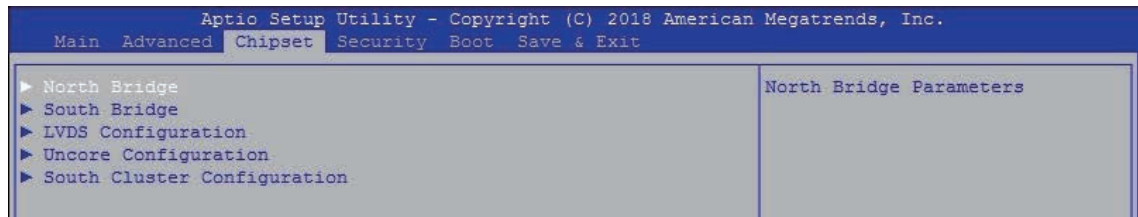

Figure 4-4 : Chipset

### North Bridge

North Bridge Parameters.

### South Bridge

South Bridge Parameters.

### LVDS Configuration

LVDS Configuration.

### Uncore Configuration

Uncore Configuration.

### South Cluster Configuration

South Cluster Configuration.

## 4.4.1 North Bridge

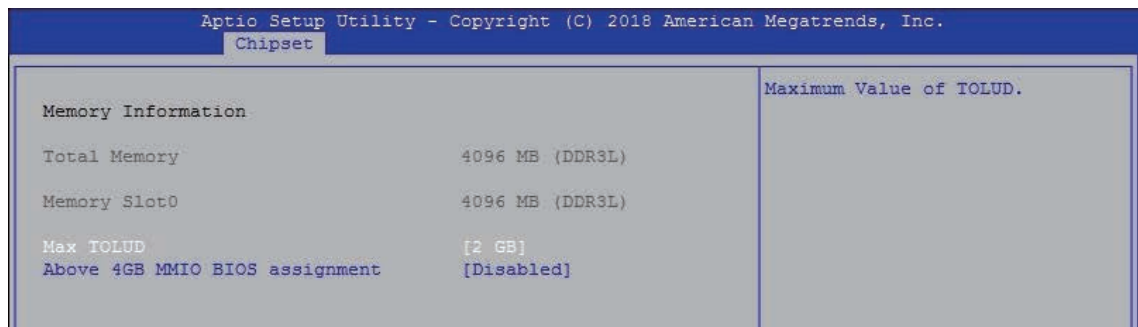

Figure 4-4-1 : North Bridge Settings

### Max TOLUD

Maximum Value of TOLUD.

### Above 4GB MMIO BIOS assignment

Enable/Disable above 4GB MemoryMappedIO BIOS assignment. This is disabled automatically when Aperture Size is set to 2048MB.

## 4.4.2 South Bridge

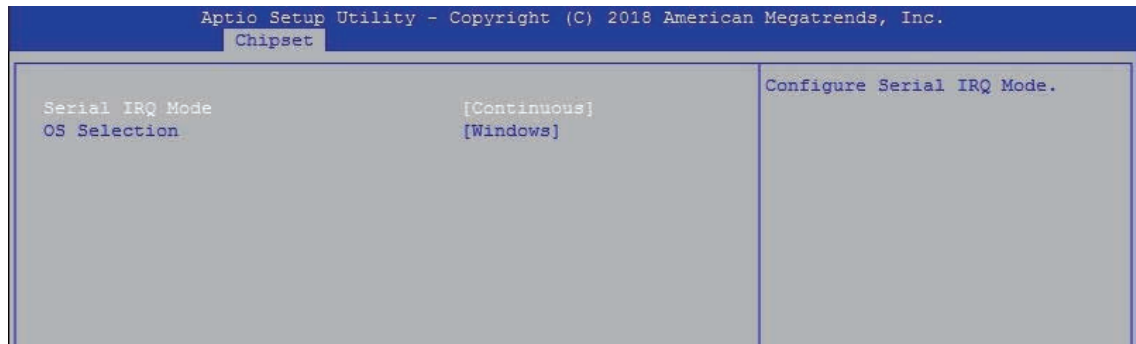

Figure 4-4-2 : South Bridge

### Serial IRQ Mode

Configure Serial IRQ Mode.

### OS Selection

Select the target OS. There are some settings difference between windows and Linux. We advise you to change this option with the OS you will use.

## 4.4.3 LVDS Configuration

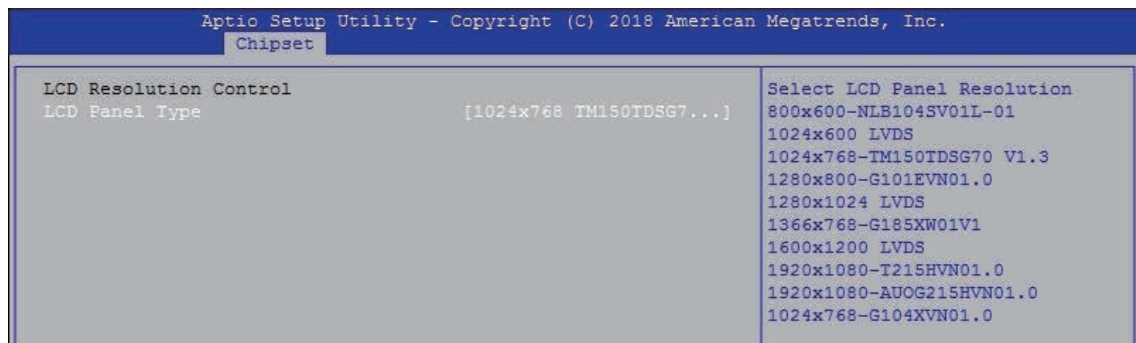

Figure 4-4-3 : LVDS Panel Settings

The LVDS Configuration option will be present if LVDS panel is connected on system.

### LCD Panel Type

Select LCD Panel Resolution.

## 4.4.4 Uncore Configuration

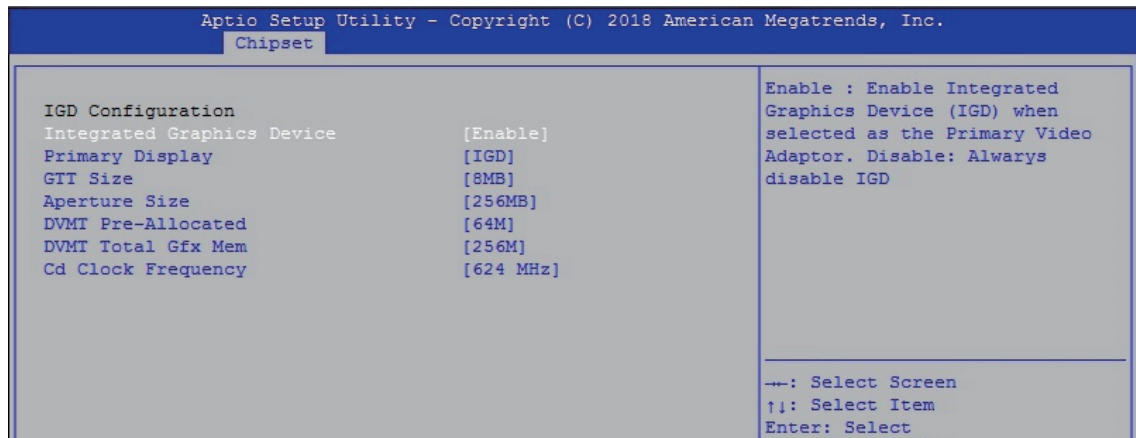

Figure 4-4-4 : Uncore Configuration

### Integrated Graphics Device

Enable : Enable Integrated Graphics Device (IGD) when selected as the Primary Video Adaptor. Disable : Always disable IGD.

### Primary Display

Select which of IGD/PCI Graphics device should be Primary Display

### GTT Size

Select the GTT Size

Aperture Size

Select the Aperture Size

### DVMT Pre-Allocated

Select DVMT 5.0 Pre-Allocated (Fixed) Graphics Memory size used by the Internal Graphics Device

### DVMT Total Gfx Mem

Select DVMT5.0 Total Graphic Memory size used by the Internal Graphics Device

### Cd Clock Frequency

Select the highest Cd Clock frequency supported by the platform



## 4.4.5 South Cluster configuration



Figure 4-4-5 : South Cluster Settings

### 4.4.5.1 PCI Express Configuration

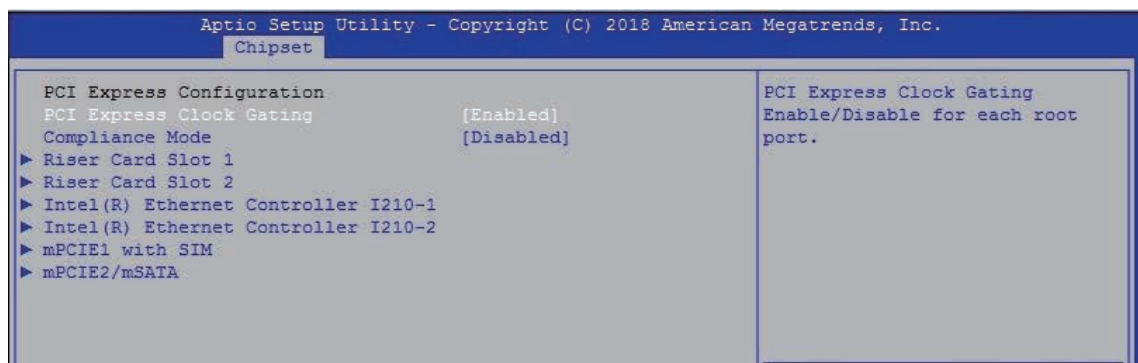

Figure 4-4-5-1 : PCI Express Settings

#### PCI Express Clock Gating

PCI Express Clock Gating Enable/Disable for each root port.

#### Compliance Mode

Compliance Mode Enable/Disable.

#### Riser Card Slot

Riser Card Slot settings.

#### Intel(R) Ethernet Controller I210

Intel(R) Ethernet Controller I210 Settings

#### Mini PCIe Slot with SMI

Mini PCIe Slot with SIM settings.

#### Mini PCIe/mSATA

Mini PCIe/mSATA Slot Settings.

## 4.4.5.2 SATA Drivers

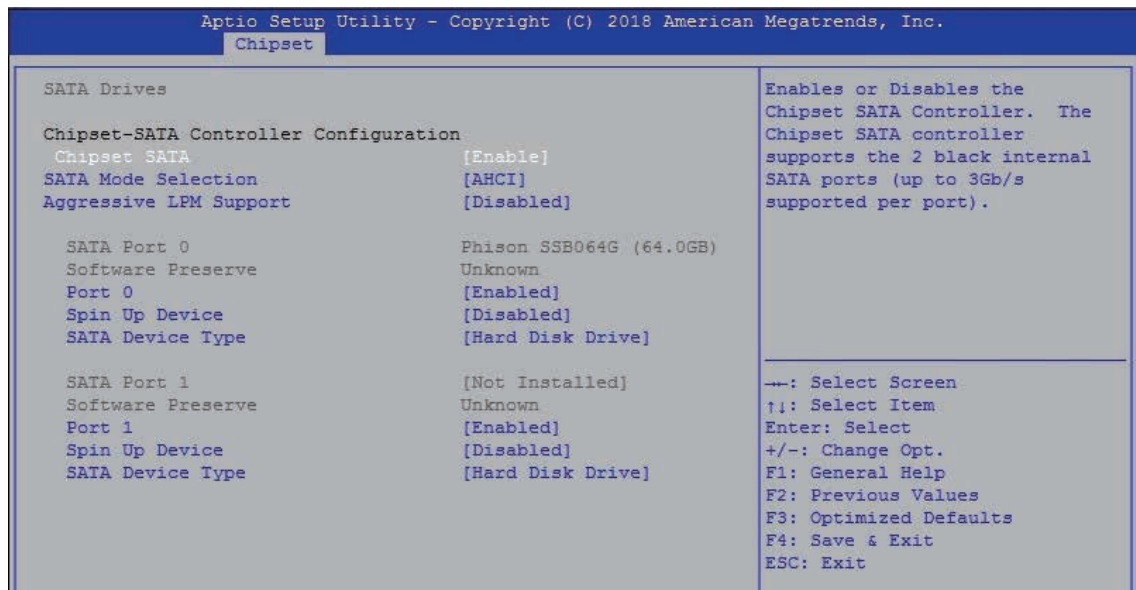

Figure 4-4-5-2 : SATA Devices Settings

### Chipset SATA

Enables or Disables the Chipset SATA Controller. The Chipset SATA controller supports the 2 black internal SATA ports (up to 3Gb/s supported per port).

### SATA Mode Selection

Determines how SATA controller(s) operate.

### Aggressive LPM Support

Enable PCH to aggressively enter link power state.

### Options for each SATA port :

#### Port 0/1

Enable or Disable SATA Port.

### Spin up Device

If enabled for any of ports Staggered Spin Up will be performed and only the drives which have this option enabled will spin up at boot. Otherwise all drives spin up at boot.

### SATA Device Type

Identify the SATA port is connected to Solid State Drive or Hard Disk Drive.

### 4.4.5.3 Miscellaneous Configuration



Figure 4-4-5-3 : Miscellaneous Configuration

#### State After G3

Specify what state to go to when power is re-applied after a power failure (G3 state).

S0 State : System will boot directly as soon as power applied.

S5 State : System keeps in power-off state until power button is pressed.

#### Board Clock Spread Spectrum

Enable Clock Chip's Spread Spectrum feature.

#### Wake On Lan

Enable or Disable the Wake on Lan.

#### BIOS Lock

Enable/Disable the SC BIOS Lock Enable feature. Required to be enabled to ensure SMM protection of flash.

#### RTC Lock

Enable will lock bytes 38h-3Fh in the lower/upper 128-byte bank of RTC RAM.

#### Flash Protection Range Registers (FPRR)

Enable Flash Protection Range Registers.

## 4.5 Security

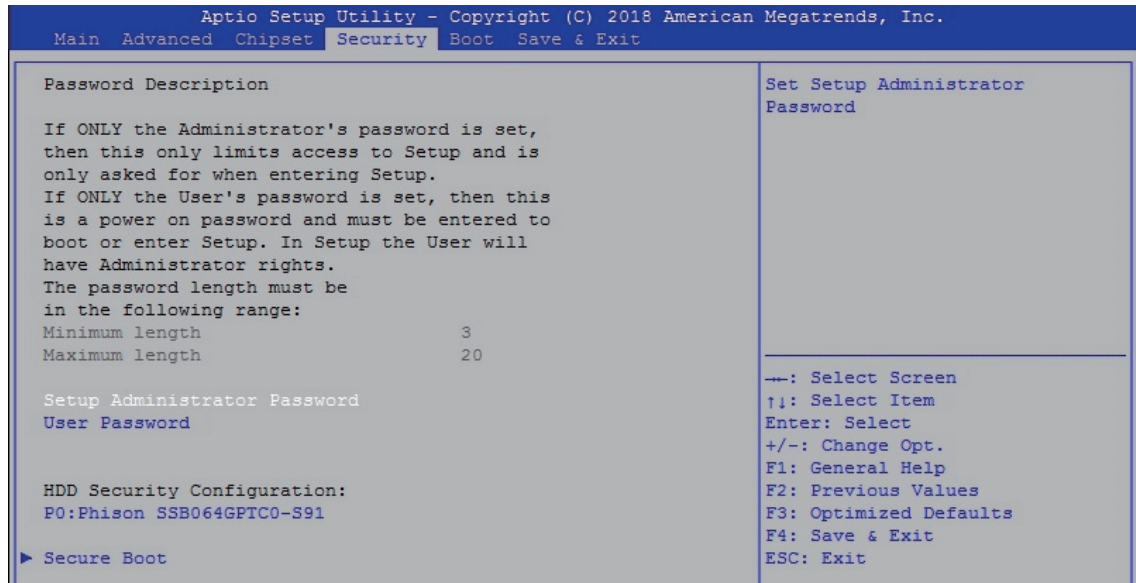

Figure 4-5 : BIOS Security Menu

### Setup Administrator Password

Set Setup Administrator Password

### User Password

Set User Password

### Secure Boot

Customizable Secure Boot Settings.

## 4.5.1 HDD Security Configuration

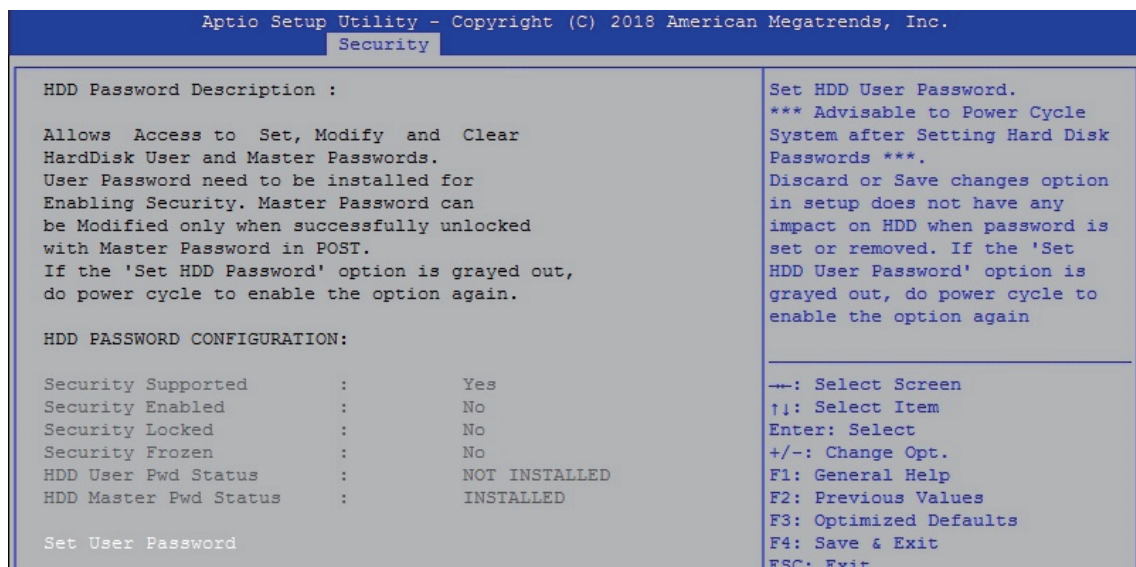

Figure 4-5-1 : HDD Security Settings

### Set User Password

Set HDD user password.

\*\*\*Advisable to Power Cycle System after Setting Hard Disk Passwords\*\*\*

Discard or save changes option in setup does not have any impact on HDD when password is set or removed. If the "Set HDD User Password" option is grayed out, do power cycle to enable the option again.

## 4.5.2 Security Boot



Figure 4-5-2 : Security Boot Settings

### Secure Boot

Secure Boot activated when : Secure Boot is enabled Platform Key (PK) is enrolled, System mode is User/Deployed, and CSM is disabled.

### Secure Boot Customization

Secure Boot mode – Custom & Standard, Set UEFI Secure Boot mode to STANDARD mode or CUSTOM mode, this change is effect after save. And after reset, the mode will return to STANDARD mode.

### Key Management

Enables expert users to modify Secure Boot Policy variables without full authentication.

## 4.6 Boot

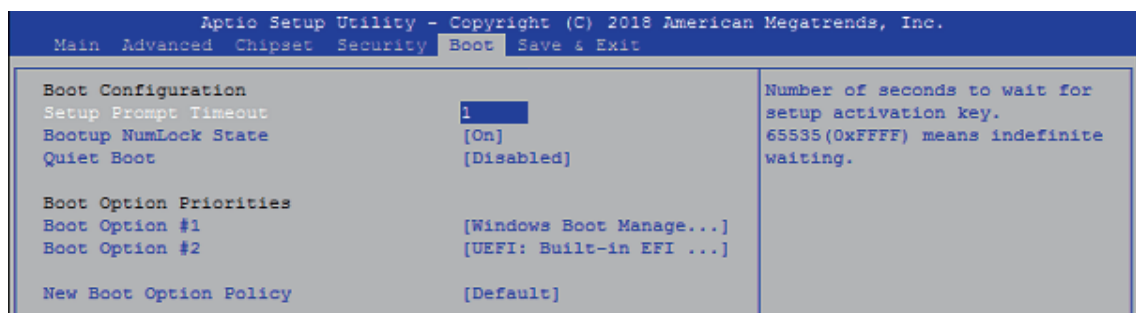

Figure 4-6 : BIOS Boot Menu

### Setup Prompt Timeout

Number of seconds to wait for setup activation key. 65535 (0xFFFF) means indefinite waiting.

### Bootup NumLock State

Select the keyboard NumLock state.

### Quiet Boot

Enables or disables Quiet Boot option.

### Boot Option #x

Sets the system boot order.

### New Boot Option Policy

Controls the placement of newly detected UEFI boot options.

## 4.7 Save & Exit

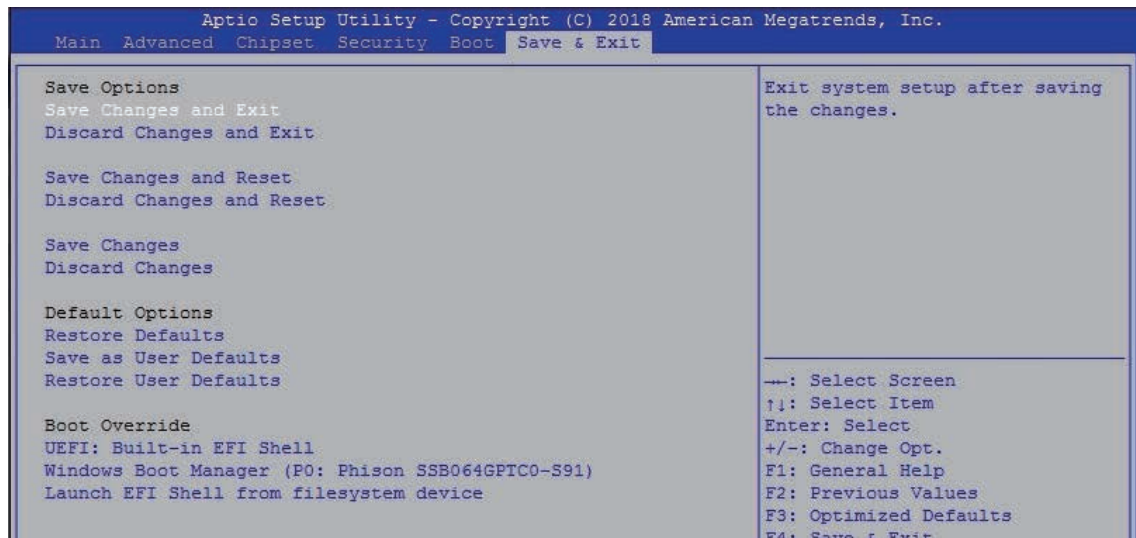

Figure 4-7 : BIOS Save and Exit Menu

### Save Changes and Exit

Exit system setup after saving the changes.

### Discard Changes and Exit

Exit system setup without saving any changes.

### Save Changes and Reset

Reset the system after saving the changes.

### Discard Changes and Reset

Reset system setup without saving any changes.

### Save Changes

Save Changes done so far to any of the setup options.

### Discard Changes

Discard Changes done so far to any of the setup options.

### Default options :

#### Restore Defaults

Restore/Load Default values for all the setup options.

#### Save as User Defaults

Save the changes done so far as User Defaults.

#### Restore User Defaults

Restore the User Defaults to all the setup options.

# A

## APPENDIX A : GPIO Guide

### A.1 Function Description

SEC-2000 offers a 16-bit GPIO a pair of 10-bit internal connector and a watchdog timer.

GPIO definition is shown below :

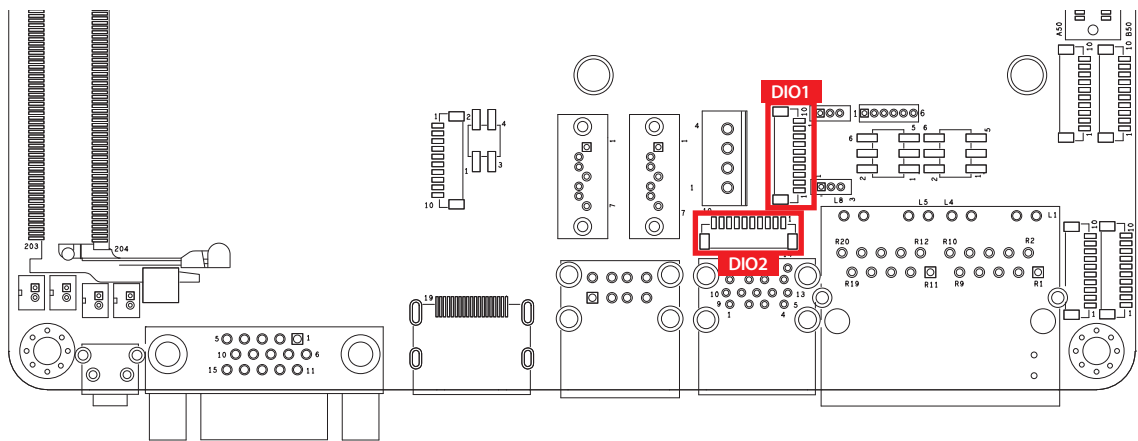

Pin No.	JDIO1 Definition	JDIO2 Definition
1	SIO_GPO70	SIO_GPI80
2	SIO_GPO71	SIO_GPI81
3	SIO_GPO72	SIO_GPI82
4	SIO_GPO73	SIO_GPI83
5	SIO_GPO74	SIO_GPI84
6	SIO_GPO75	SIO_GPI85
7	SIO_GPO76	SIO_GPI86
8	SIO_GPO77	SIO_GPI87
9	+3.3V	+3.3V
10	GND	GND

## A.2 Software Package Contain

Distribution folder include x32 and x64 versions, use batch file for installation.

There are included as followed :

Win7\_32.bat :

Installation for 32-bit driver

Win7\_64.bat :

Windows update package which driver required (need to restart), and

Installation for 64-bit driver

Win8\_32.bat, Win8\_64.bat :

Installation for driver, and guideline to Framework 3.5 distribution for sample

Win10\_32.bat, and Win10\_64.bat :

Installation for driver, and installation to Framework 3.5 distribution for sample

Uninstall\_32.bat, and Uninstall\_64.bat :

Uninstallation for driver

Run batch file as Administrator.

Support Windows 7 above.

Make sure Windows version before installation.

Runtime folder include head file for software developer or System Integration.

Sample folder include sample program, driver library, and API library.

Source folder include sample program source code that compile on Visual Studio 2008.

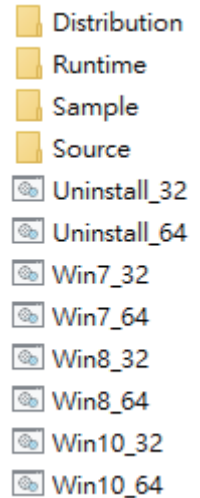

## A.3 Sample

Execute DIO demo tool (SEC2K.exe).

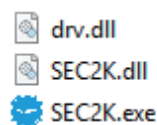

Sample SEC2K.exe, as shown below :

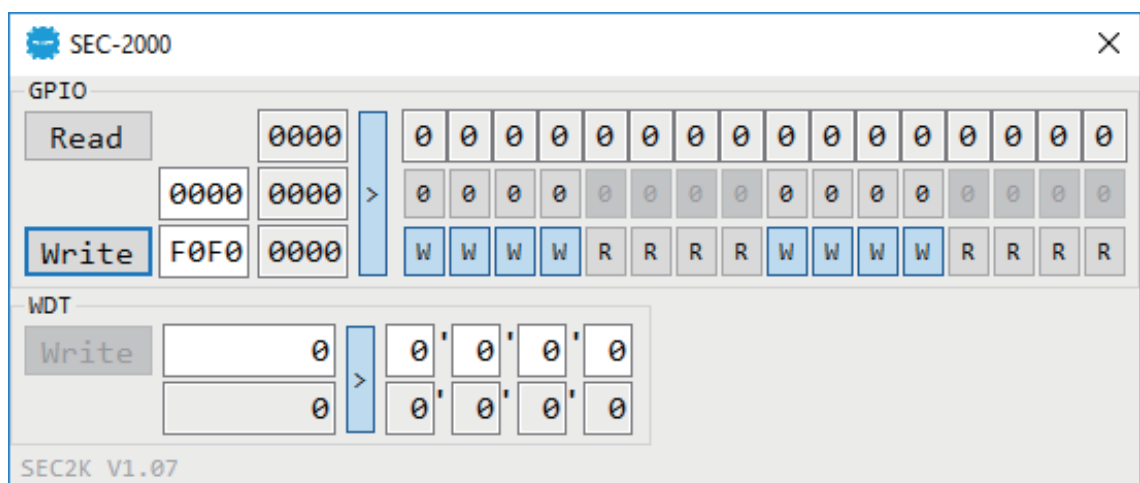



### **GPIO group :**

Read button :

Set GPIO configuration to get GPIO state.

Write button :

Set GPIO configuration to set GPIO state.

GPIO output text :

User setting, GPIO output state by hexadecimal bitmask - High/Low.

Use for Write button activate.

GPIO writable text :

User setting, GPIO writable of GPIO configuration by hexadecimal bitmask - yes/no.

Use for Read/Write button activate.

GPIO input text (read only) :

GPIO input state by hexadecimal bitmask - High/Low.

Use for Read button activate.

GPIO text (read only) :

GPIO output state with input state and configuration.

Use for Write button activate.

GPIO output text (read only) :

GPIO output state with configuration.

Use for Write button activate.

GPIO input pin check button (read only, pin 18 ~ pin 11, pin 8 ~ pin 1):

GPIO input pin state

Use for Read button activate.

GPIO output pin check button (pin 18 ~ pin 11, pin 8 ~ pin 1):

User setting, GPIO output pin state

Use for Write button activate.

GPIO pin writable check button (pin 18 ~ pin 11, pin 8 ~ pin 1):

User setting, GPIO pin writable of GPIO configuration.

Use for Read/Write button activate.

### **WDT group :**

Write button :

Set WDT when WDT setup text is valid.

Stop button :

Cancel WDT and counting.

Use after Write button action.

WDT setup text :

User setting, WDT value, unit : second.

Use for Write button activate.

WDT counting text (read only) :

WDT counting by program timer after set WDT.

Shown after Write button action.

WDT setup day format texts (user setting) :

User setting, WDT value, format : day'hour'minute'second..

WDT counting day format text (read only) :

WDT counting, format : day'hour'minute'second.

# B

## APPENDIX B : Software Functions

### B.1 Driver API Guide

In Runtime folder, on SEC2K.h :

  \_DLL\_IMPORT\_ definition is used on LoadLibrary API for SEC2K.dll.

  SEC2K\_EXPORTS definition is used on SEC2K.dll building.

  Otherwise, that is used to compile with SEC2K.lib

#### **BOOL Initial()**

Initial machine for GPIO, and watchdog timer

Return:

  TRUE (1): Success;

  FALSE (0): Fail (Driver not exists, or initial error (version is too old, or machine not match))

#### **BOOL GetGPIOConfig(WORD \*Mask)**

Get GPIO configuration (by variable)

  Mask ([15:0]): In/Out, pin setting by hexadecimal bitmask

  1: Output; 0: Input

Return :

  TRUE (1): Success;

  FALSE (0): Fail (Initial error, or call by pointer error, or hardware problem)

#### **BOOL SetGPIOConfig(WORD Mask)**

Set GPIO configuration

  Mask ([15:0]): In/Out, pin setting by hexadecimal bitmask

  1: Output; 0: Input

Return :

  TRUE (1): Success;

  FALSE (0): Fail (Initial error, or hardware problem)

#### **BOOL GetGPIO(WORD \*DI)**

Get GPIO input

  DI ([15:0]): Input state, pin setting by hexadecimal bitmask

  1: High; 0: Low

Return :

  TRUE (1): Success;

  FALSE (0): Fail (Initial error, or call by pointer error, or hardware problem)

**BOOL SetGPIO(WORD DO)**

Set GPIO output

DO ([15:0]): output state, pin setting by hexadecimal bitmask  
1: High; 0: Low

Return:

TRUE (1): Success;

FALSE (0): Fail (Initial error, or hardware problem)

**BOOL GetWDT (DWORD \*WDT)**

Get watchdog timer setup

WDT : watchdog timer setup

Unit : second. (Range : 0 ~ 65535 sec, 1093 ~ 65535 min (=65580 ~ 3932100 sec))

Return :

TRUE (1) : Success;

FALSE (0) : Fail (Initial error, or call by pointer error, or hardware problem)

**BOOL SetWDT (DWORD WDT)**

Set watchdog timer setup

WDT : watchdog timer setup

Unit : second. (Range : 1 ~ 65535 sec, 1093 ~ 65535 min (=65580 ~ 3932100 sec))

Return :

TRUE (1) : Success;

FALSE (0) : Fail (Initial error, or setup 0 error, or hardware problem)

**BOOL CancelWDT ()**

Cancel watchdog timer

Return :

TRUE (1) : Success;

FALSE (0) : Fail (Initial error, or hardware problem)

# C

## APPENDIX C : RAID Functions

### C.1 SATA Mode for RAID

Please select SATA device to RAID mode on BIOS menu.  
Advanced → SATA Configuration → SATA Mode Selection

Main	Advanced	Chipset	Boot	Security	Save & Exit
SATA Controller(s) [Enabled]					Item Specific Help
SATA Model Selection [AHCI]					

### C.2 OS Installation

SEC-2000 is featured with three SATA, including two internal SATA and 1 mSATA. You can select one of the SATA ports for OS installation. We use CFast card for Windows 10 OS installation as an example.

### C.3 To Install All Device Drivers of SEC-2000 System

The instructions are as follows :

1. To install Chipset driver
2. To install Network driver
3. To install ME driver (if available)
4. To install Audio driver
5. To install VGA driver

### C.4 To Install "Intel Rapid Storage Technology" Software

You can get the latest information and the software directly from Intel website.

[http://www.intel.com/p/en\\_US/support/highlights/chpsts/imsm](http://www.intel.com/p/en_US/support/highlights/chpsts/imsm)

The RAID environment has been done if you completed the steps above.

## C.5 To Insert SATA HDD for RAID 1

Please notice, you can use two SATA ports for SATA HDD or one SATA port for SATA HDD with one slot for mSATA.

## C.6 To Create RAID Volume on "Rapid Storage Technology" Software

SEC-2000 is featured with three SATA devices for RAID volume, so there are three options for choose on this page. Let's take RAID 1 as an example, please select "RAID 1".

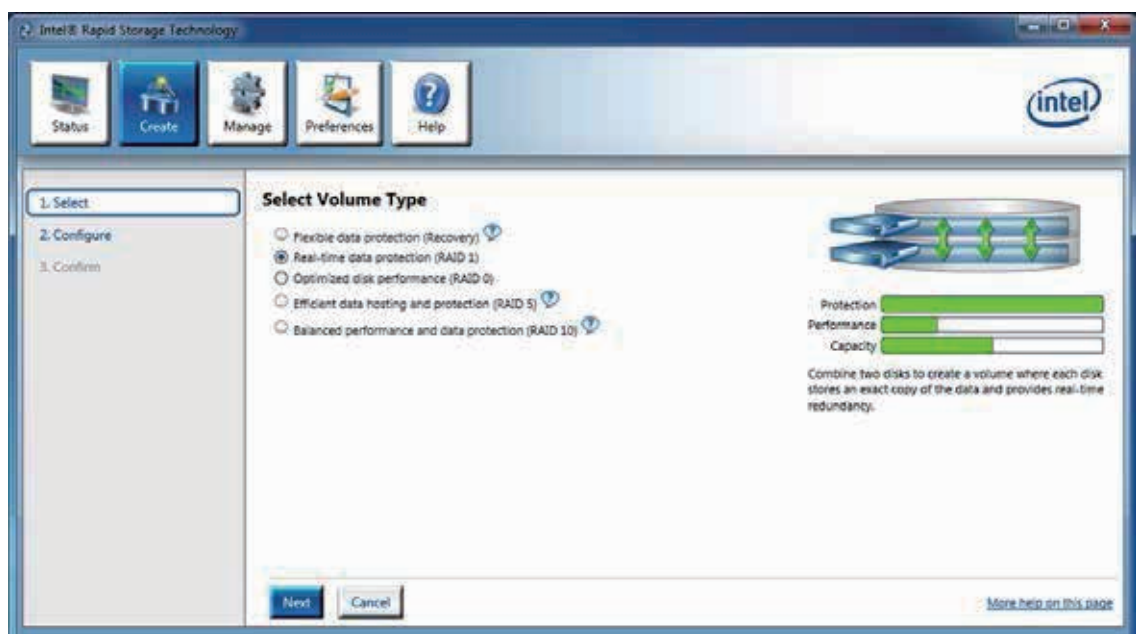

## C.7 Disk Management : Partition the Disk

After RAID 1 volume created, you can see the figure of SATA device allocation.

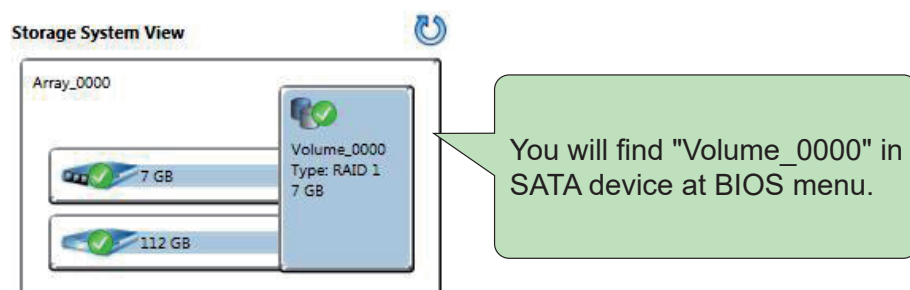

To start Disk Management tool, select "initialize disk."

Then add "Logical Device" for Windows access.

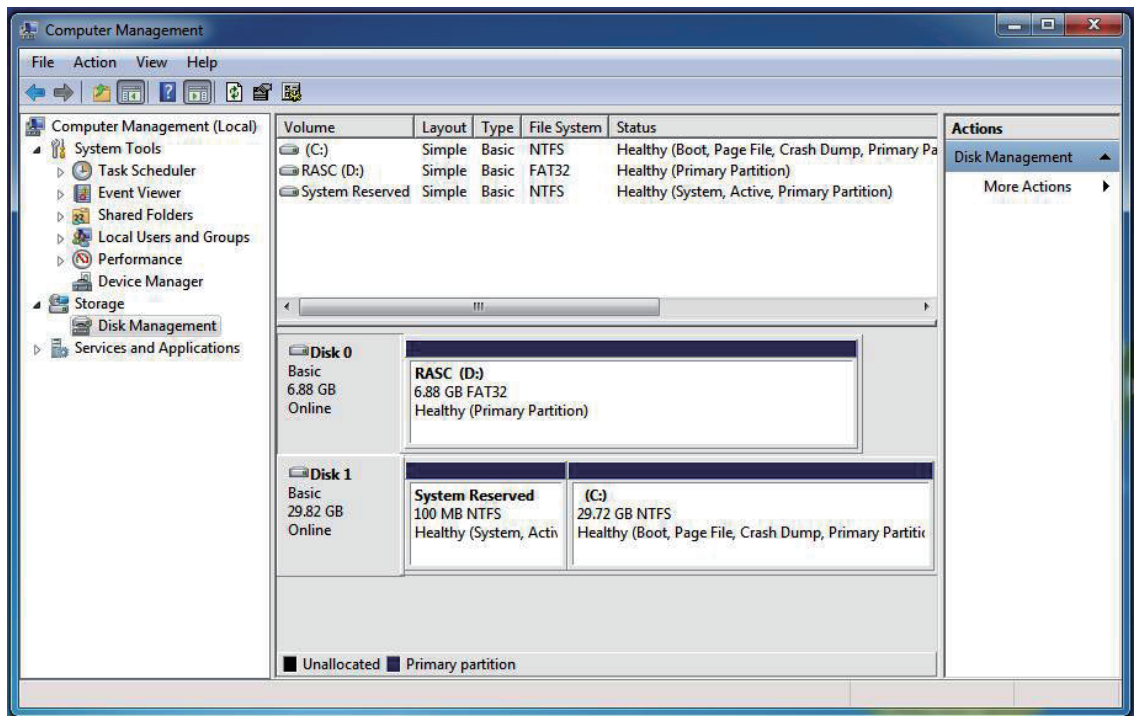

## C.8 If One SATA HDD on RAID Volume is Out-of-use

After RAID 1 volume created, you can see the figure of SATA device allocation.

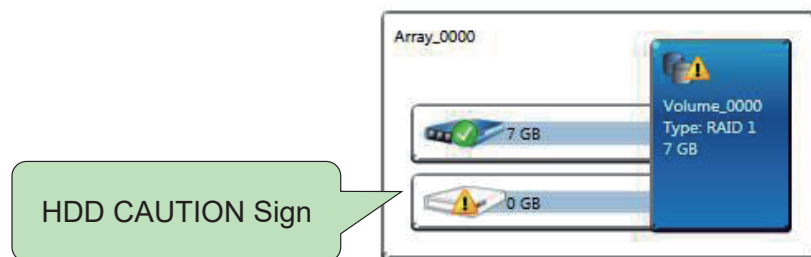

## C.9 Recovery and Auto Rebuild When Use the **SAME** RAID HDD

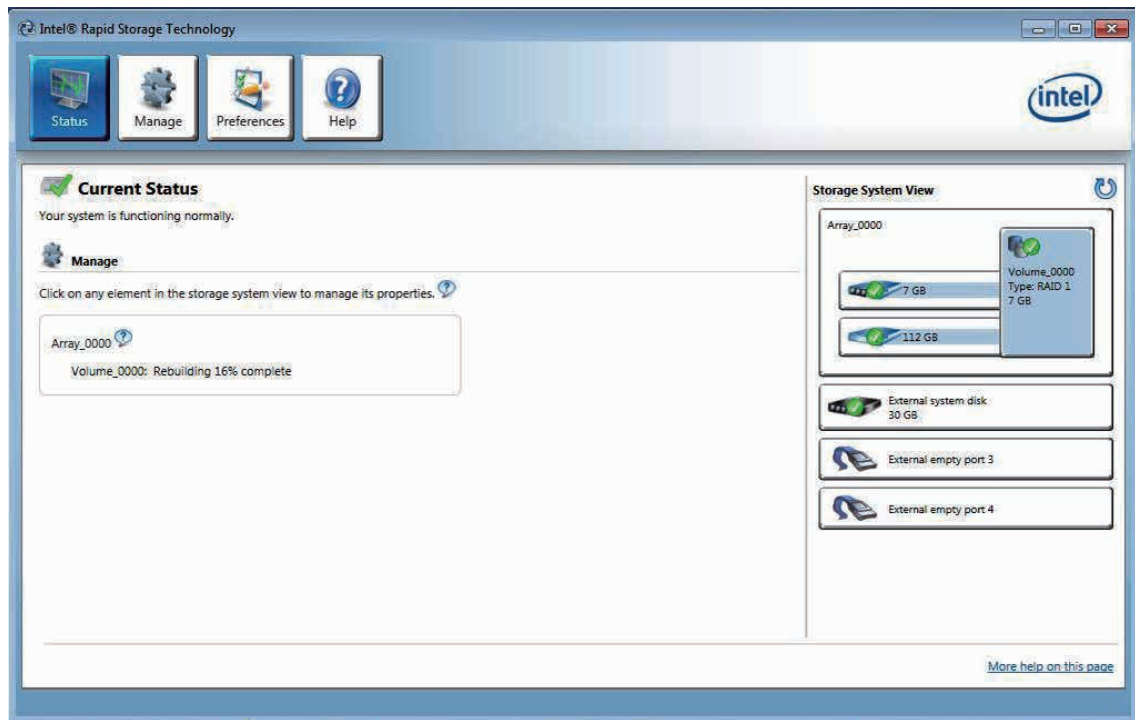

## C.10 Recovery and Auto Rebuild When Use **DIFFERENT** RAID HDD

A warning will pop-up to ask you if the disk is not a member of the original RAID volume.

If you press "Rebuild", it will replace the broken SATA HDD to the last SATA HDD of RAID volume.

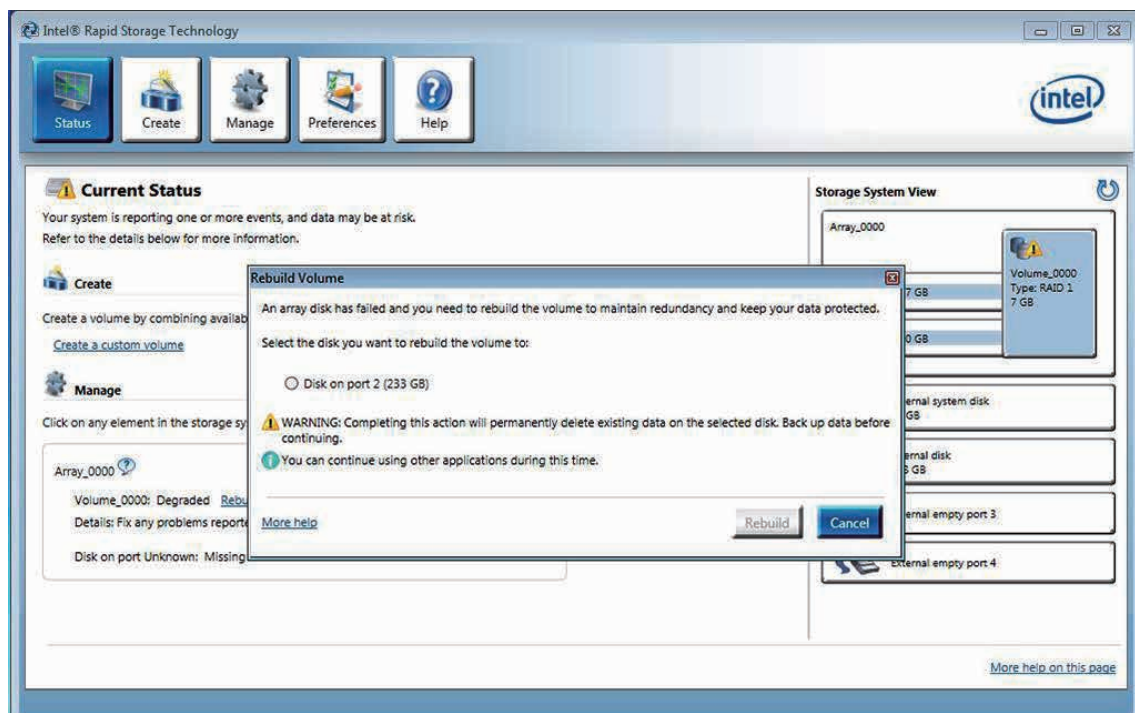

# D

## APPENDIX D : Power Consumption

Testing Board	SEC-2000
RAM	8GB x1
USB-1	USB Keyboard Microsoft Wired Keyboard 600
USB-2	USB Mouse Logitech M105
USB-3	USB Flash ADATA 3.0 16GB
USB-4	USB Flash Transcend 3.0 16GB
CFAST	N/A
SATA 0	Intel® SSD E5400s 120GB
SATA 1	Toshiba HDD MQ01ABD050 500GB
LAN 1 (I210)	1.0Gbps
LAN 2 (I210)	1.0Gbps
Graphics Output	HDMI
Power Plan	Balance (Windows 10 Power Plan)
Power Source	Chroma 62006P-100-25



## D.1 Intel Atom® x7-E3950 1.6GHz (Apollo Lake) (2M Cache, up to 2.00GHz) Without Turbo Mode

CPU	Power Input	Standby Mode		Power on and boot to Win 7 (64-bit)			
				Sleep Mode		idle status CPU usage less 3%	
		Max Current	Max Consumption	Max Current	Max Consumption	Max Current	Max Consumption
Apollo Lake x7-E3950	12V	0.247A	02.96W	0.186A	02.23W	0.838A	10.06W

CPU	Power Input	Power on and boot to Win 7 (64bit)			
		Run 100% CPU usage without 3D		Run 100% CPU usage with 3D	
		Max Current	Max Consumption	Max Current	Max Consumption
Apollo Lake x7-E3950	12V	1.119A	13.43W	1.603A	19.24W

## D.2 Intel Atom® x7-E3950 1.6GHz (Apollo Lake) (2M Cache, up to 2.00GHz) With Turbo Mode

CPU	Power Input	Standby Mode		Power on and boot to Win 7 (64-bit)			
				Sleep Mode		idle status CPU usage less 3%	
		Max Current	Max Consumption	Max Current	Max Consumption	Max Current	Max Consumption
Apollo Lake x7-E3950	12V	0.274A	03.29W	0.187A	02.24W	0.885A	10.62W

CPU	Power Input	Power on and boot to Win 7 (64bit)			
		Run 100% CPU usage without 3D		Run 100% CPU usage with 3D	
		Max Current	Max Consumption	Max Current	Max Consumption
Apollo Lake x7-E3950	12V	1.271A	15.25W	1.702A	20.42W

# E

## APPENDIX E : Supported Memory & Storage List

### E.1 Test Item

Testing Board	SEC-2000
Memory Test	Version : 5.1
Burn-in Test	V8.1

Channel	Memory Test	Burn-in Test	Flash BIOS	Remove Battery	Sleep	Hibernate	Reset	CPU-Z
*1 (Socket 1)	PASS	PASS	PASS	PASS	PASS	PASS	PASS	PASS

### E.2 NON-ECC

Brand	Info	Test Temp. (Celsius)
Vecow 4GB 240PIN DDR3L-1333 SODIMM	M340L-W28M1	25°C
		25°C
Kingston 2GB 240PIN DDR3L-1600 SODIMM	KVR16LS11S6/2	25°C
		25°C
Kingston 4GB 240PIN DDR3L-1600 SODIMM	KVR16LS11/4	25°C
		25°C
Crucial 4GB 240PIN DDR3L-1600 SODIMM	CT51264BF160BJ. C8FER	25°C
		25°C
Kingston 8GB 240PIN DDR3L-1600 SODIMM	KVR16LS11/8	25°C
		25°C
ATLA 4GB 240PIN DDR3L-1866 SODIMM	AD3SST4GG6WB- DMGEL	25°C
		25°C
ATLA 8GB 240PIN DDR3L-1866 SODIMM	AD3SST8GSAWB- DMGEL	25°C
		25°C

### E.3 Supported Storage Device List

Type	Vendor	Model	Capacity
mSATA	Intel	Intel-310 SSDMAEMC080G2	80GB
SATA SSD	Kingston	SUV400S37/120G	120GB
	Innodisk	3MG2-P DGS25-64GD81BC1QC	64GB
	Intel	SSD 540s SSDSC2KW120H6	120GB
	Intel	SSD E 5400s SSDSC2KR120H6	120GB
	MEMXPRO	2.5" SSD M3A 128GB	128GB
	LITE-ON	K8-L1256	256GB
	LITE-ON	K8-L1512	512GB
SATA HDD	TOSHIBA	MQ01ABF050	500GB

# F

## APPENDIX F : Install Win11 (BIOS TPM Setting)

**Step 1** Click on “Advanced”, then click on “PCH-FW Configuration”

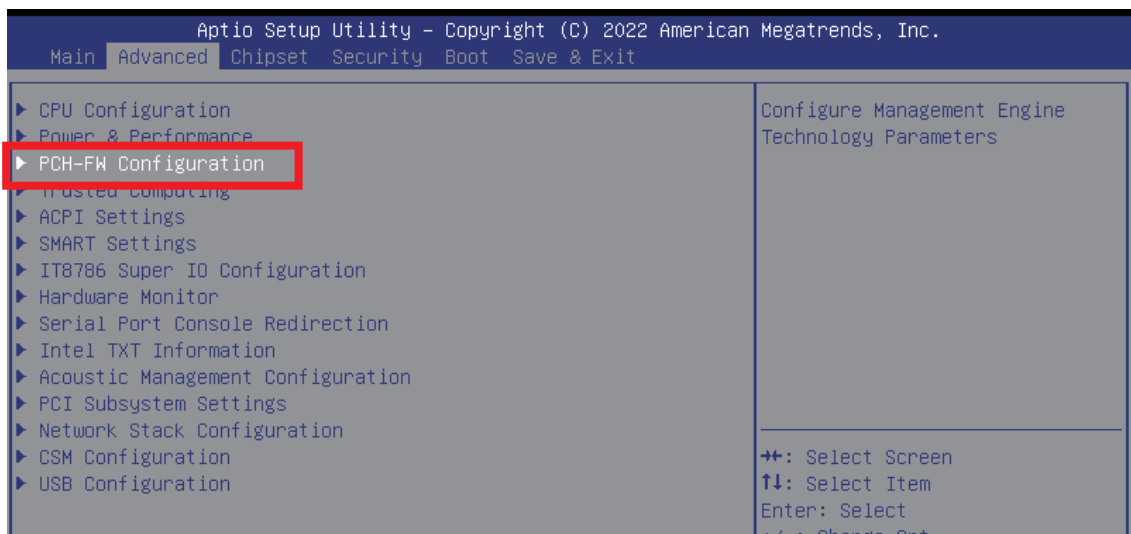

**Step 2** Click on “PTT Configuration”

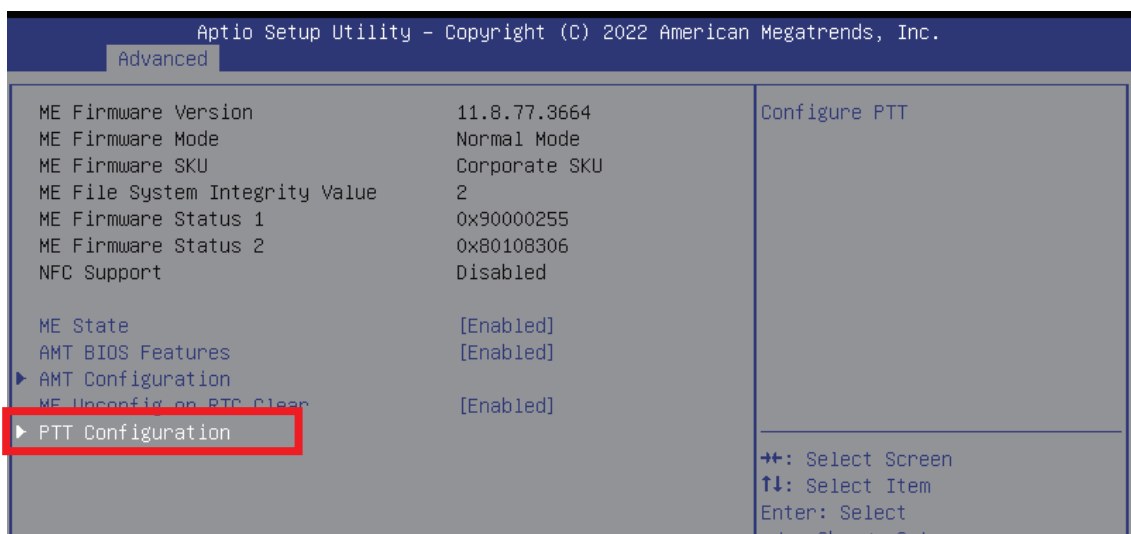

**Step 3** Click on “dTPM” (TPM Device Selection)

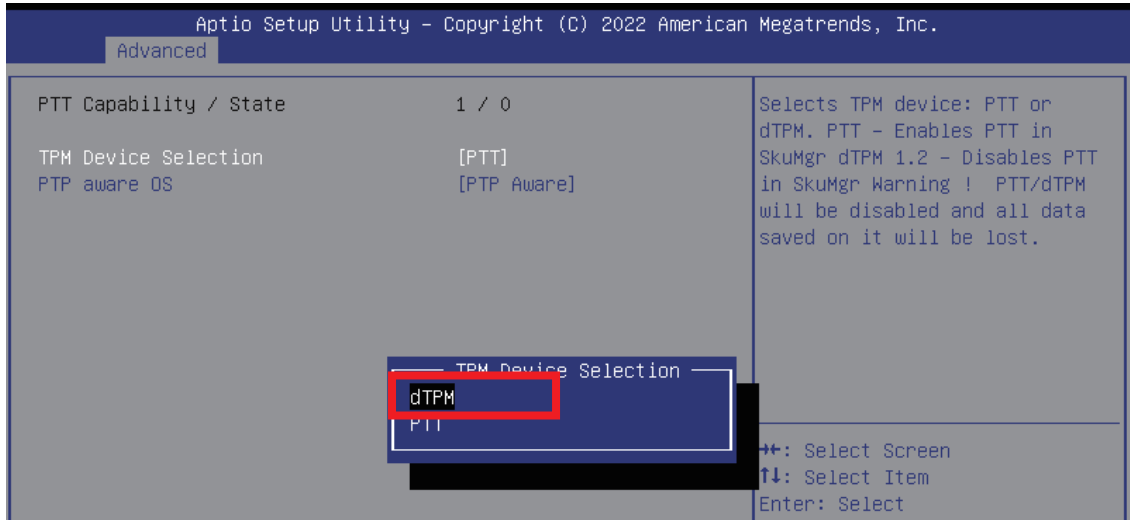

**Step 4** Please save the BIOS settings by pressing F4. Please press Enter when the pop-up window which asks “Save configuration and exit?” appears. The computer will then restart.

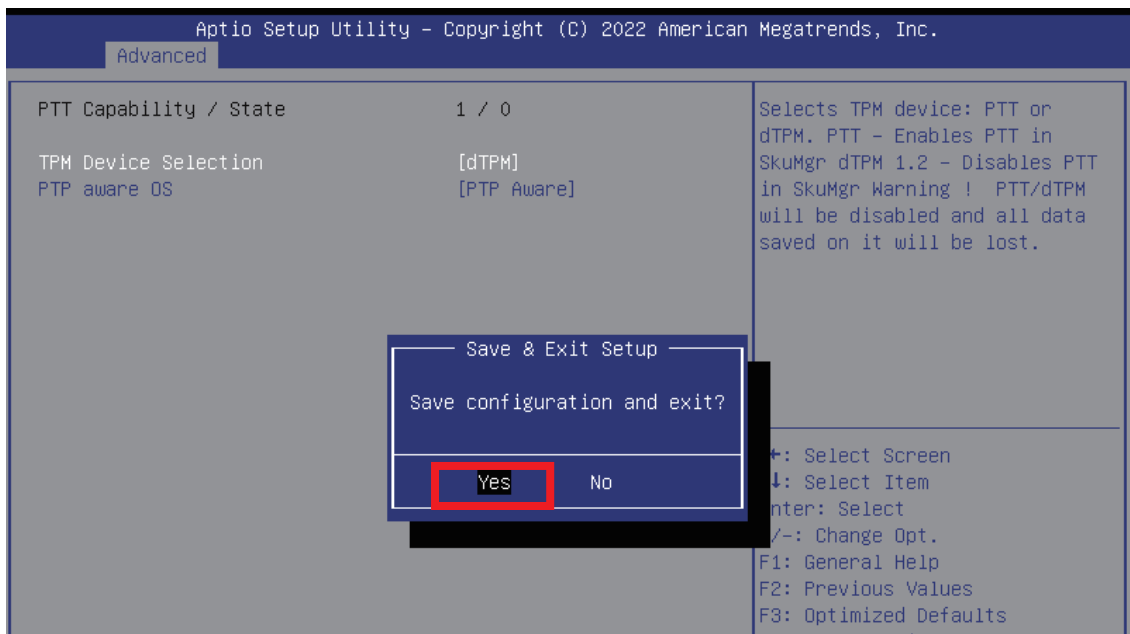

### Step 5 Click on “Trusted Computing”

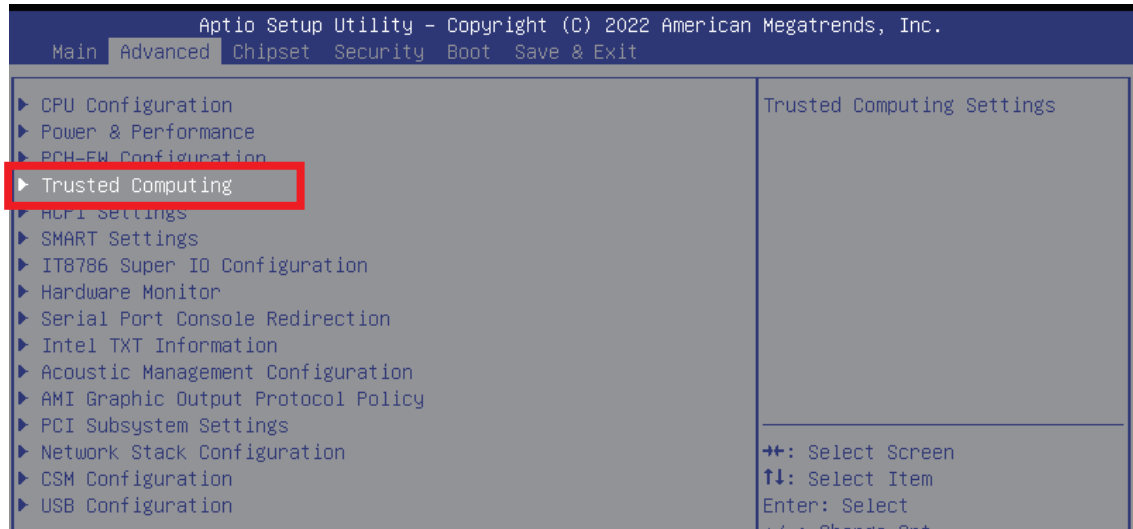

### Step 6 If the window shows “TPM2.0 Device Found Firmware Version:5.62”, then the setting is completed.

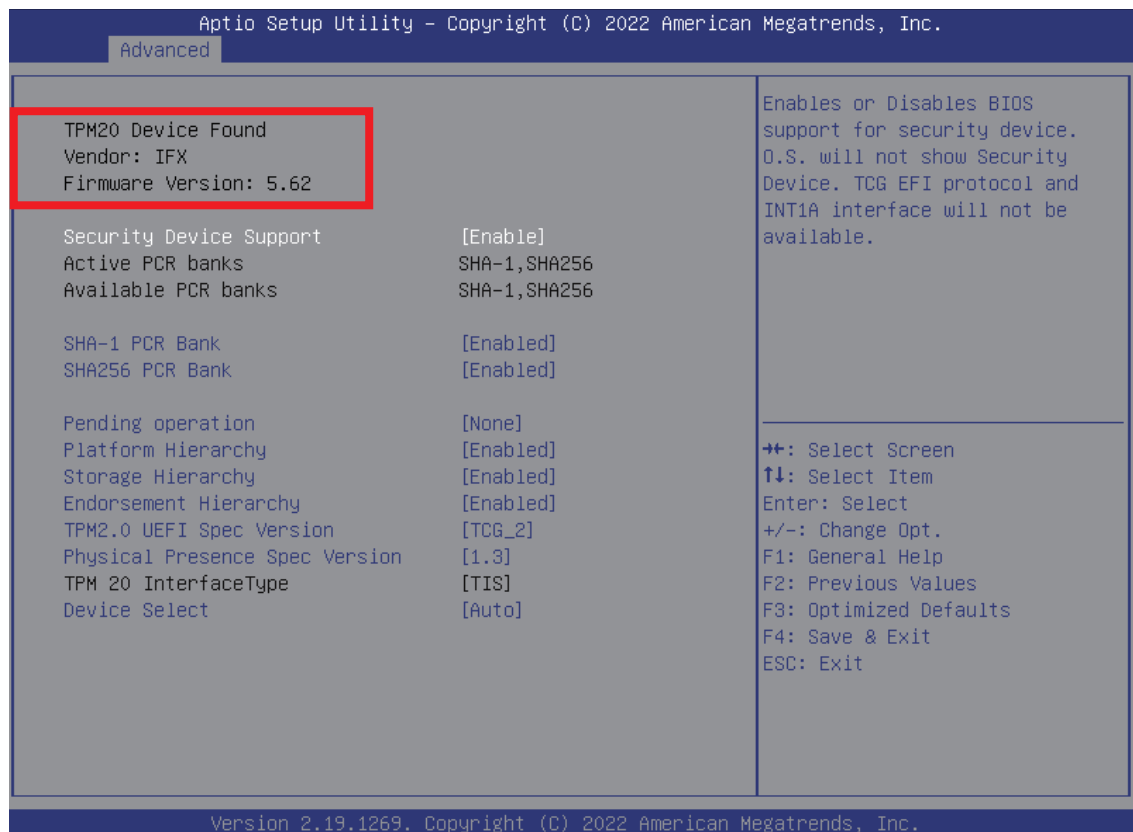

\*\* If more help is needed, please contact Vecow technical support \*\*



For further support information, please visit [www.vecow.com](http://www.vecow.com)

This document is released for reference purpose only.

All product offerings and specifications are subject to change without prior notice.

No part of this publication may be reproduced in any form or by any means, electric, photocopying, or recording, without prior authorization from the publisher.

The rights of all the brand names, product names, and trademarks belong to their respective owners.

© Vecow Co., Ltd. 2019. All rights reserved.